

TPD4E001 Low-Capacitance 4-Channel ESD-Protection for High-Speed Data Interfaces

1 Features

- IEC 61000-4-2 ESD Protection (Level 4)
 - ± 8 -kV Contact Discharge
 - ± 15 -kV Air-Gap Discharge
- 5.5-A Peak Pulse Current (8/20- μ s Pulse)
- IO Capacitance: 1.5 pF (Typical)
- Low Leakage Current: 1 nA (Maximum)
- Low Supply Current: 1 nA
- 0.9-V to 5.5-V Supply-Voltage Range
- Space-Saving DRL, DBV, DCK, DPK, and DRS Package Options
- Alternate 2, 3, 6-Channel options Available: TPD2E001, TPD3E001, TPD6E001

2 Applications

- USB 2.0
- Ethernet
- FireWire™ Serial Bus
- LVDS
- SVGA Video Connections
- Glucose Meters

3 Description

The TPD4E001 is a four-channel Transient Voltage Suppressor (TVS) based Electrostatic Discharge (ESD) protection diode array. The TPD4E001 is rated to dissipate ESD strikes at the maximum level specified in the IEC 61000-4-2 international standard (Level 4). This device has a 1.5-pF IO capacitance per channel, making it ideal for use in high-speed data IO interfaces. The ultra low leakage current (< 1 nA maximum) is suitable for precision analog measurements in applications like glucose meters and heart rate monitors.

The TPD4E001 is available in DRL(SOT), DBV (SOT-23), DCK (SC-70), DRS (QFN), and DPK (PUSON) packages and is specified for -40°C to $+85^{\circ}\text{C}$ operation. See also the [TPD4E1U06DCKR](#) and [TPD4E1U06DBVR](#) which are p2p compatible with the [TPD4E001DCKR](#) and [TPD4E001DBVR](#). These devices offer higher IEC protection, lower capacitance, lower clamping voltage, and eliminate the input capacitor requirement.

Device Information⁽¹⁾

PART NUMBER	PACKAGE	BODY SIZE (NOM)
TPD4E001	SOT (6)	1.60 mm x 1.20 mm
		2.90 mm x 1.60 mm
	SC70 (6)	2.00 mm x 1.25 mm
	USON (6)	1.60 mm x 1.60 mm
	SON (6)	3.00 mm x 3.00 mm

(1) For all available packages, see the orderable addendum at the end of the data sheet.

Application Schematic

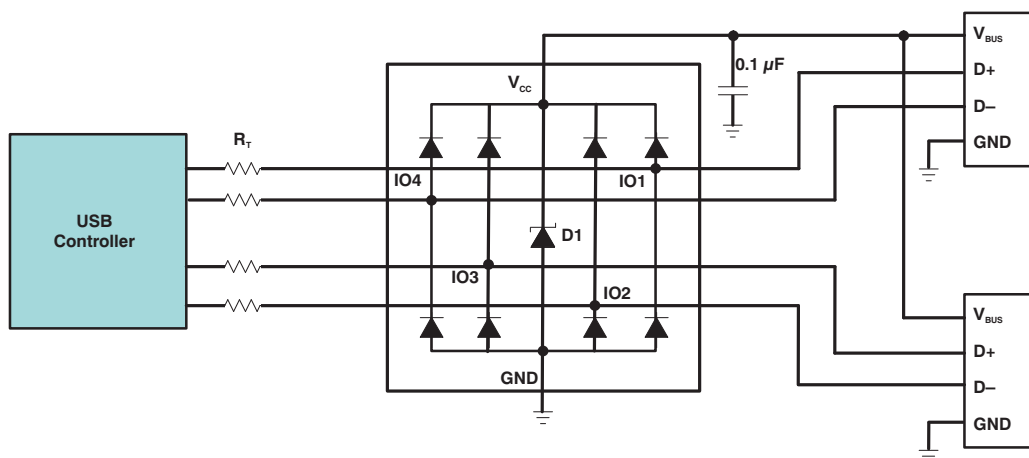

Table of Contents

1 Features	1	7.4 Device Functional Modes.....	8
2 Applications	1	8 Application and Implementation	9
3 Description	1	8.1 Application Information.....	9
4 Revision History	2	8.2 Typical Application	9
5 Pin Configuration and Functions	4	9 Power Supply Recommendations	11
6 Specifications	5	10 Layout	11
6.1 Absolute Maximum Ratings	5	10.1 Layout Guidelines	11
6.2 ESD Ratings—JEDEC Specification.....	5	10.2 Layout Example	11
6.3 ESD Ratings—IEC Specification	5	11 Device and Documentation Support	12
6.4 Recommended Operating Conditions.....	5	11.1 Documentation Support	12
6.5 Thermal Information	6	11.2 Related Links	12
6.6 Electrical Characteristics.....	6	11.3 Receiving Notification of Documentation Updates	12
6.7 Typical Characteristics	7	11.4 Community Resources.....	12
7 Detailed Description	8	11.5 Trademarks	12
7.1 Overview	8	11.6 Electrostatic Discharge Caution.....	12
7.2 Functional Block Diagram	8	11.7 Glossary	12
7.3 Feature Description.....	8	12 Mechanical, Packaging, and Orderable Information	12

4 Revision History

NOTE: Page numbers for previous revisions may differ from page numbers in the current version.

Changes from Revision N (March 2018) to Revision O	Page
• Added TPD4E001R DBV Package image and updated Pin Functions table.....	4
Changes from Revision M (May 2017) to Revision N	Page
• TPD4E001DBVR Device Marking changed from NFY to NIFYF	12
Changes from Revision L (May 2016) to Revision M	Page
• Updated Pin Functions table and DCK2 Package image.....	4
• Updated "Surge Protection" to "IEC Specification" in <i>ESD Ratings—IEC Specification</i> table.....	5
Changes from Revision K (January 2015) to Revision L	Page
• Added frequency test condition to <i>Channel input capacitance</i> in the <i>Electrical Characteristics</i> table	6
• Added <i>Community Resources</i>	12
Changes from Revision J (December 2013) to Revision K	Page
• Added <i>Pin Configuration and Functions</i> section, <i>ESD Ratings</i> table, <i>Feature Description</i> section, <i>Device Functional Modes</i> , <i>Application and Implementation</i> section, <i>Power Supply Recommendations</i> section, <i>Layout</i> section, <i>Device and Documentation Support</i> section, and <i>Mechanical, Packaging, and Orderable Information</i> section	1
Changes from Revision I (September 2012) to Revision J	Page
• Updated Description.	1
• Removed Ordering Information table.	4

Changes from Revision H (August 2012) to Revision I **Page**

- Added DCK2 package to Pin Out drawings. 4
 - Updated Electrical Characteristics table 6
-

Changes from Revision G (December 2011) to Revision H **Page**

- Updated TOP-SIDE MARKING column in ORDERING INFORMATION table. 4
-

Changes from Revision F (May 2011) to Revision G **Page**

- Updated document formatting. 1
 - Added DPK (PUSON) package and package information. 4
-

Changes from Revision E (April 2011) to Revision F **Page**

- Added Peak Pulse Waveform Graph to Typical Operating Characteristics. 7
-

Changes from Revision C (April 2007) to Revision D **Page**

- Added DBV (SOT-23) package and package information..... 4
-

5 Pin Configuration and Functions

**DRL Package
6-Pin SOT
Top View**

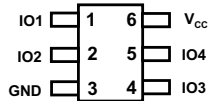

**DCK2 Package
6-Pin SC70
Top View**

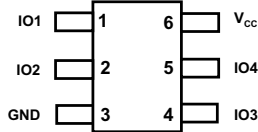

**DBV or DCK Package
6-Pin SOT or SC70
Top View**

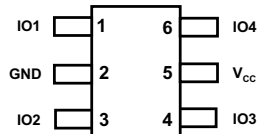

**DRS Package
6-Pin SON
Top View**

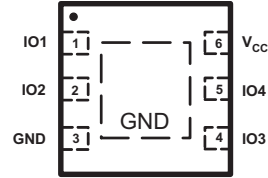

**DPK Package
6-Pin USON
Top View**

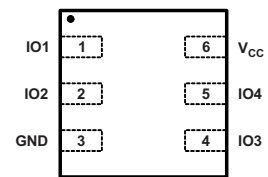

**TPD4E001R DBV Package
6-Pin SOT
Top View**

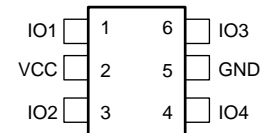

Pin Functions

NAME	PIN			I/O	DESCRIPTION
	DRS, DRL, DPK	DBV, DCK	TPD4E001R		
GND	3	2	5	—	Ground
IOx	1	1	1	I	ESD-protected channel
	2	3	3		
	4	4	4		
	5	6	6		
V _{CC}	6	5	2	I	Power-supply input. Bypass V _{CC} to GND with a 0.1- μ F ceramic capacitor
Exposed thermal pad (DRS package only)				—	Exposed thermal pad. Connect to GND or leave floating

6 Specifications

6.1 Absolute Maximum Ratings

over operating free-air temperature range (unless otherwise noted)⁽¹⁾

		MIN	MAX	UNIT
V _{CC}		-0.3	7	V
V _{I/O}	IO voltage tolerance	-0.3	V _{CC} + 0.3	V
I _(Surge)	IEC 61000-4-5 peak pulse current (T _P = 8/20 μs), IOx pins		5.5	A
P _(Surge)	IEC 61000-4-5 peak pulse power (T _P = 8/20 μs), IOx pins		100	W
T _J	Junction temperature		150	°C
	Bump temperature (soldering)	Infrared (15 s)	220	°C
		Vapor phase (60 s)	215	
	Lead temperature (soldering, 10 s)		300	°C
T _{stg}	Storage temperature	-65	150	°C

(1) Stresses beyond those listed under *Absolute Maximum Ratings* may cause permanent damage to the device. These are stress ratings only, which do not imply functional operation of the device at these or any other conditions beyond those indicated under *Recommended Operating Conditions*. Exposure to absolute-maximum-rated conditions for extended periods may affect device reliability.

6.2 ESD Ratings—JEDEC Specification

			VALUE	UNIT
TPD4E001 in DRS, DRL, and DPK Packages				
V _(ESD)	Electrostatic discharge	Human-body model (HBM), per ANSI/ESDA/JEDEC JS-001 ⁽¹⁾	All pins except 1, 2, 4, and 5	±2000
			Pins 1, 2, 4, and 5	±15000
		Charged-device model (CDM), per JEDEC specification JESD22-C101 ⁽²⁾	All pins	±1000
TPD4E001 in DBV and DCK Packages				
V _(ESD)	Electrostatic discharge	Human-body model (HBM), per ANSI/ESDA/JEDEC JS-001 ⁽¹⁾	All pins except 1, 3, 4, and 6	±2000
			Pins 1, 3, 4, and 6	±15000
		Charged-device model (CDM), per JEDEC specification JESD22-C101 ⁽²⁾	All pins	±1000

(1) JEDEC document JEP155 states that 500-V HBM allows safe manufacturing with a standard ESD control process.

(2) JEDEC document JEP157 states that 250-V CDM allows safe manufacturing with a standard ESD control process.

6.3 ESD Ratings—IEC Specification

			VALUE	UNIT
TPD4E001 in DRS, DRL, and DPK Packages				
V _(ESD)	Electrostatic discharge	IEC 61000-4-2 contact discharge	All pins	±8000
		IEC 61000-4-2 air-gap discharge	All pins	±15000
TPD4E001 in DBV and DCK Packages				
V _(ESD)	Electrostatic discharge	IEC 61000-4-2 contact discharge	All pins	±8000
		IEC 61000-4-2 air-gap discharge	All pins	±15000

6.4 Recommended Operating Conditions

over operating free-air temperature range (unless otherwise noted)

		MIN	MAX	UNIT
T _A	Operating free-air temperature	-40	85	°C
	Operating voltage	V _{CC} pin	0.9	5.5
		IO1, IO2 pins	0	V _{CC}

6.5 Thermal Information

THERMAL METRIC ⁽¹⁾	TPD4E001					UNIT
	DRL (SOT)	DBV (SOT)	DCK (SC70)	DPK (USON)	DRS (SON)	
	6 PINS	6 PINS	6 PINS	6 PINS	6 PINS	
R _{θJA} Junction-to-ambient thermal resistance	226.4	259.7	251.1	247.6	91.9	°C/W
R _{θJC(top)} Junction-to-case (top) thermal resistance	90.3	186.5	88.1	124.8	106.9	°C/W
R _{θJB} Junction-to-board thermal resistance	61.2	107.6	54.8	204.2	64.8	°C/W
Ψ _{JT} Junction-to-top characterization parameter	6.7	71.4	1.7	19.2	10.2	°C/W
Ψ _{JB} Junction-to-board characterization parameter	61	107.1	54.1	209.3	64.9	°C/W
R _{θJC(bot)} Junction-to-case (bottom) thermal resistance	N/A	N/A	N/A	N/A	29.9	°C/W

(1) For more information about traditional and new thermal metrics, see the [Semiconductor and IC Package Thermal Metrics](#) application report.

6.6 Electrical Characteristics

over operating free-air temperature range (unless otherwise noted), V_{CC} = 5 V ± 10%

PARAMETER	TEST CONDITIONS	MIN	TYP ⁽¹⁾	MAX	UNIT
V _{CC} Supply voltage		0.9		5.5	V
I _{CC} Supply current			1	100	nA
V _F Diode forward voltage	I _F = 10 mA	0.65		0.95	V
V _{BR} Breakdown Voltage	I _{BR} = 10 mA	11			V
V _C Channel clamp voltage	T _A = 25°C, ±15-kV HBM, I _F = 10 A	Positive transients		V _{CC} + 25	V
		Negative transients		-25	
	T _A = 25°C, ±8-kV contact discharge (IEC 61000-4-2), I _F = 24 A	Positive transients		V _{CC} + 60	
		Negative transients		-60	
	T _A = 25°C, ±15-kV air-gap discharge (IEC 61000-4-2), I _F = 45 A	Positive transients		V _{CC} + 100	
Negative transients		-100			
	Surge strike on IO pin, GND pin grounded, I _{PP} = 5 A, 8/20 μs ⁽²⁾		17		
V _{RWM} Reverse stand-off voltage	IO pin to GND pin			5.5	V
I _{I/O} Channel leakage current	V _{I/O} = GND to V _{CC}			±1	nA
C _{I/O} Channel input capacitance	V _{CC} = 5 V, bias of V _{CC} /2; f = 10 MHz		1.5		pF

(1) Typical values are at V_{CC} = 5 V and T_A = 25°C.

(2) Non-repetitive current pulse 8/20 μs exponentially decaying waveform according to ICE61000-4-5.

6.7 Typical Characteristics

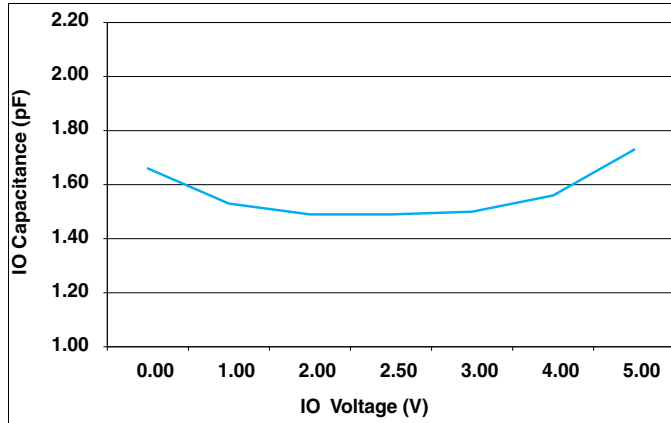

Figure 1. IO Capacitance vs IO Voltage (V_{CC} = 5 V)

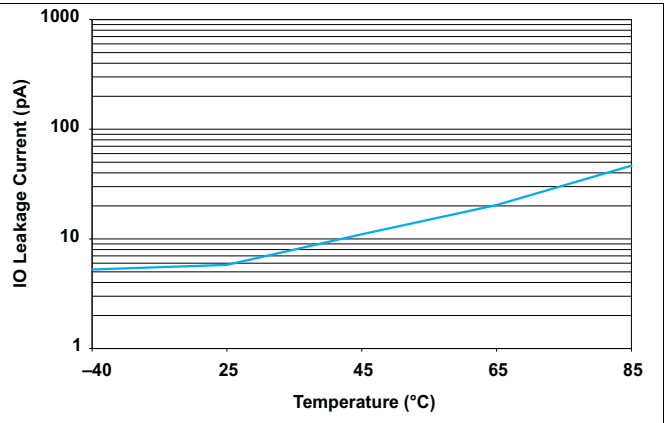

Figure 2. IO Leakage Current vs Temperature (V_{CC} = 5.5 V)

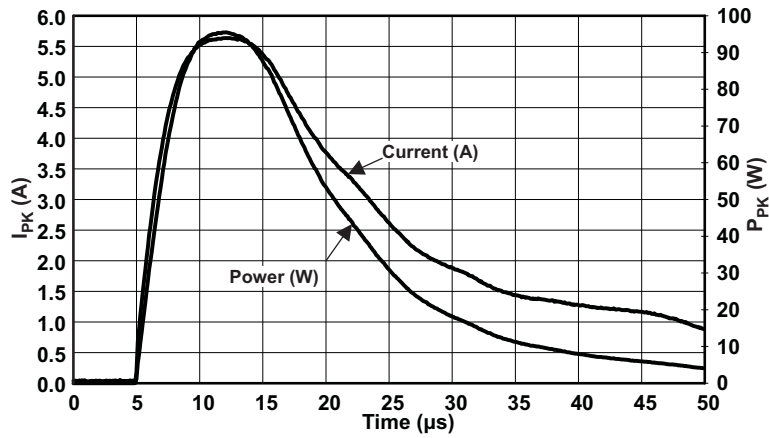

Figure 3. Peak Pulse Waveform, V_{CC} = 5.5 V

7 Detailed Description

7.1 Overview

The TPD4E001 is a four-channel transient voltage suppressor (TVS) based ESD protection diode array. The TPD4E001 is rated to dissipate ESD strikes at the maximum level specified in the IEC 61000-4-2 international standard (Level 4). This device has a 1.5-pF IO capacitance per channel, making it ideal for use in high-speed data IO interfaces. The ultra-low leakage current (<1 nA maximum) is suitable for precision analog measurements in applications like glucose meters and heart rate monitors.

7.2 Functional Block Diagram

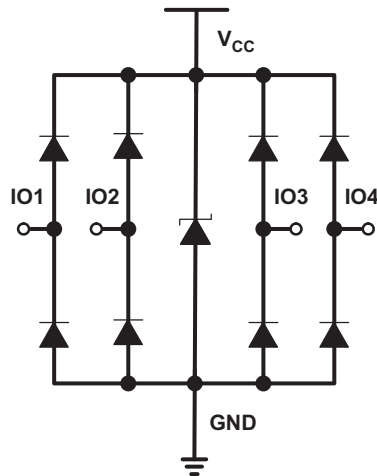

7.3 Feature Description

The TPD4E001 is a uni-directional ESD protection device with low capacitance. The device is constructed with a central ESD clamp that features two hiding diodes per line to reduce the capacitive loading. This central ESD clamp is also connected to V_{CC} to provide protection for the V_{CC} line. Each IO line is rated to dissipate ESD strikes above the maximum level specified in the IEC 61000-4-2 level 4 international standard. The TPD4E001's low loading capacitance makes it ideal for protection high-speed signal terminals.

7.4 Device Functional Modes

The TPD4E001 is a passive-integrated circuit that activates whenever voltages above V_{BR} or below the lower diodes V_{forward} (–0.6 V) are present upon the circuit being protected. During ESD events, voltages as high as ±15 kV can be directed to ground and V_{CC} via the internal diode network. Once the voltages on the protected lines fall below the trigger voltage of the TPD4E001 (usually within 10s of nano-seconds) the device reverts back to a high-impedance state.

8 Application and Implementation

NOTE

Information in the following applications sections is not part of the TI component specification, and TI does not warrant its accuracy or completeness. TI's customers are responsible for determining suitability of components for their purposes. Customers should validate and test their design implementation to confirm system functionality.

8.1 Application Information

The TPD4E001 is a diode array type Transient Voltage Suppressor (TVS) which is typically used to provide a path to ground for dissipating ESD events on hi-speed signal lines between a human interface connector and a system. As the current from ESD passes through the TVS, only a small voltage drop is present across the diode. This is the voltage presented to the protected IC. The low R_{DYN} of the triggered TVS holds this voltage, V_{CLAMP} , to a tolerable level to the protected IC.

8.2 Typical Application

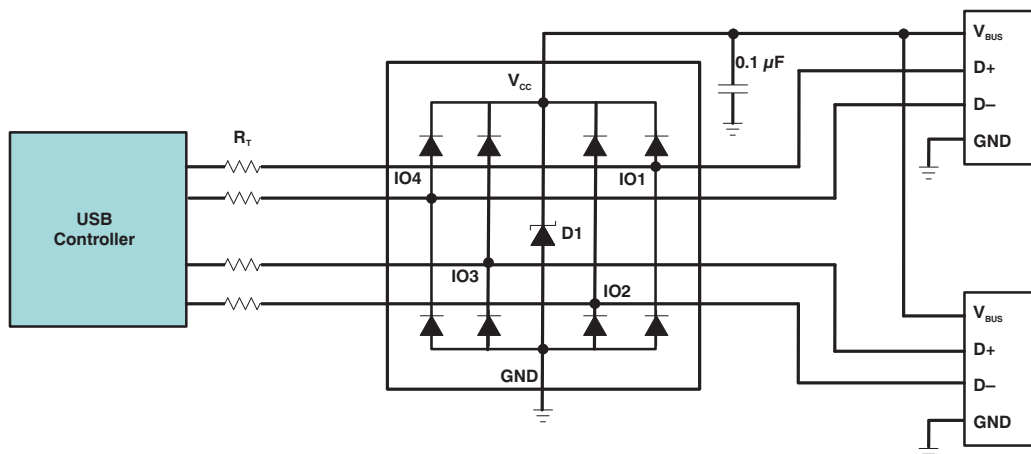

Figure 4. Typical Application Schematic

8.2.1 Design Requirements

For this design example, a single TPD4E001 is used to protect all the pins of two USB2.0 connectors. Given the USB application, the following parameters in Table 1 are known.

Table 1. Design Parameters

DESIGN PARAMETER	VALUE
Signal range on IO1, IO2, IO3, and IO4	0 V to 3.6 V
Signal voltage range on V_{CC}	0 V to 5.25 V
Operating Frequency	240 MHz

8.2.2 Detailed Design Procedure

When placed near the USB connectors, the TPD4E001 ESD solution offers little or no signal distortion during normal operation due to low IO capacitance and ultra-low leakage current specifications. The TPD4E001 ensures that the core circuitry is protected and the system is functioning properly in the event of an ESD strike. For proper operation, the following layout/ design guidelines must be followed:

1. Place the TPD4E001 solution close to the connectors. This allows the TPD4E001 to take away the energy associated with ESD strike before it reaches the internal circuitry of the system board.
2. Place a 0.1- μ F capacitor very close to the V_{CC} pin. This limits any momentary voltage surge at the IO pin during the ESD strike event.

3. Ensure that there is enough metallization for the V_{CC} and GND loop. During normal operation, the TPD4E001 consumes nA leakage current. But during the ESD event, V_{CC} and GND may see 15 A to 30 A of current, depending on the ESD level. Sufficient current path enables safe discharge of all the energy associated with the ESD strike.
4. Leave the unused IO pins floating. In this example of protecting two USB ports, none of the IO pins are left unused.
5. The V_{CC} pin can be connected in two different ways:
 - a. If the V_{CC} pin is connected to the system power supply, the TPD4E001 works as a transient suppressor for any signal swing above $V_{CC} + V_F$. A 0.1- μ F capacitor on the device V_{CC} pin is recommended for ESD bypass.
 - b. If the V_{CC} pin is not connected to the system power supply, the TPD4E001 can tolerate higher signal swing in the range up to 10 V. Please note that a 0.1- μ F capacitor is still recommended at the V_{CC} pin for ESD bypass.

8.2.3 Application Curve

Figure 5 is a capture of the voltage clamping waveform of TPD4E001DRL on IO3 during an 8-kV Contact IEC61000-4-2 ESD strike.

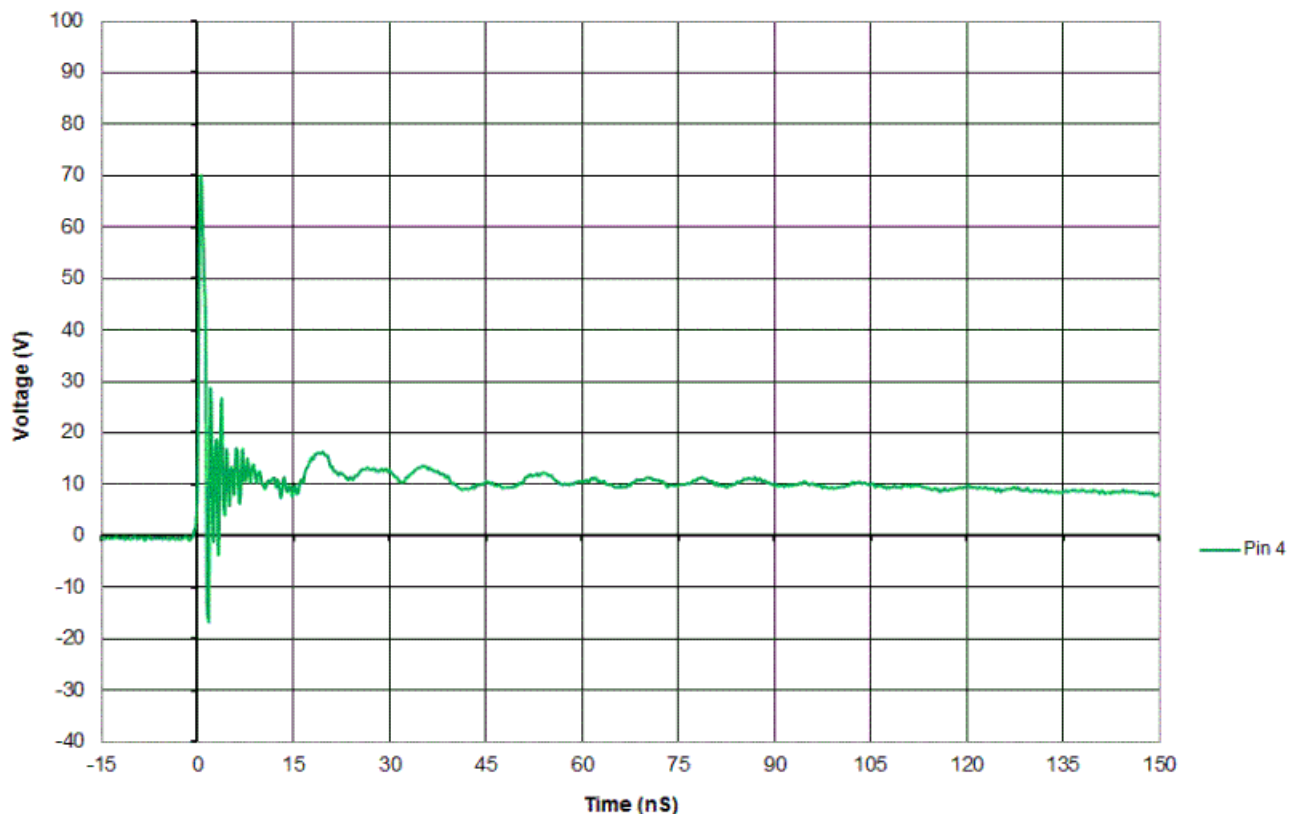

Figure 5. TPD4E001DRL IEC61000-4-2 Voltage Clamp Waveform 8-kV Contact

9 Power Supply Recommendations

This device is a passive ESD protection device so there is no need to power it. Take care to make sure that the maximum voltage specifications for each pin are not violated.

10 Layout

10.1 Layout Guidelines

- The optimum placement is as close to the connector as possible.
 - EMI during an ESD event can couple from the trace being struck to other nearby unprotected traces, resulting in early system failures.
 - The PCB designer needs to minimize the possibility of EMI coupling by keeping any unprotected traces away from the protected traces which are between the TVS and the connector.
- Route the protected traces as straight as possible.
- Eliminate any sharp corners on the protected traces between the TVS and the connector by using rounded corners with the largest radii possible.
 - Electric fields tend to build up on corners, increasing EMI coupling.

10.2 Layout Example

The following is a layout example for protecting two interface ports with the TPD4E001. One example is two USB 2.0 ports, as was discussed in the [Application and Implementation](#) section. For the USB 2.0 example, IO1 and IO2 is D+ and D–, respectively, of USB port 1. IO3 and IO4 is D– and D+, respectively, of USB port 2.

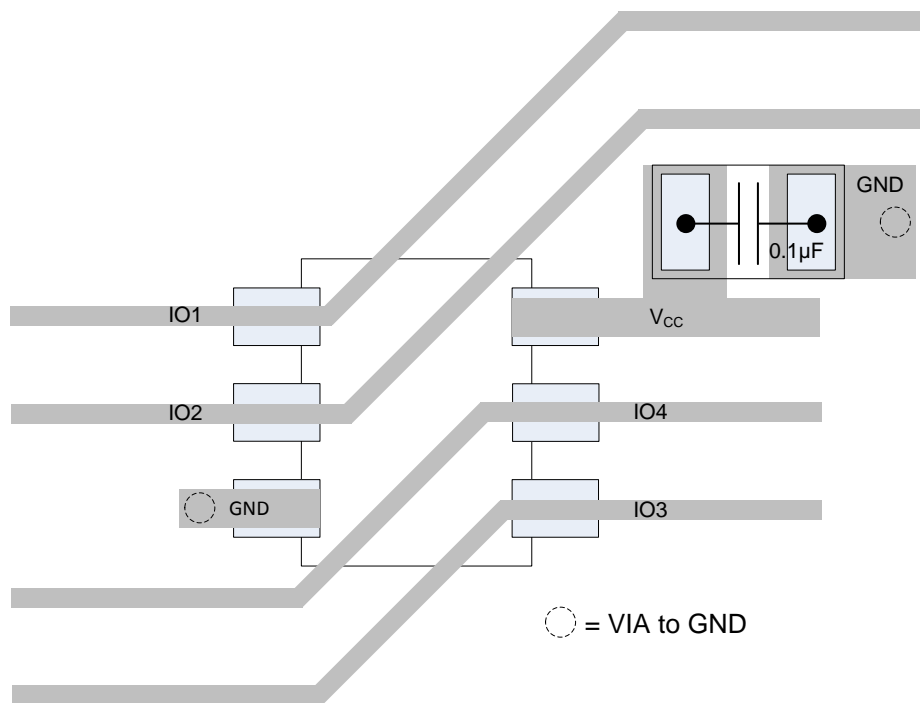

Figure 6. Routing With DRL Package

11 Device and Documentation Support

11.1 Documentation Support

11.1.1 Related Documentation

For related documentation see the following:

- [Reading and Understanding an ESD Protection Datasheet](#)
- [ESD Layout Guide](#)

11.2 Related Links

The table below lists quick access links. Categories include technical documents, support and community resources, tools and software, and quick access to sample or buy.

Table 2. Related Links

PARTS	PRODUCT FOLDER	SAMPLE & BUY	TECHNICAL DOCUMENTS	TOOLS & SOFTWARE	SUPPORT & COMMUNITY
TPD4E001	Click here	Click here	Click here	Click here	Click here
TPD4E1U06	Click here	Click here	Click here	Click here	Click here

11.3 Receiving Notification of Documentation Updates

To receive notification of documentation updates, navigate to the device product folder on ti.com. In the upper right corner, click on *Alert me* to register and receive a weekly digest of any product information that has changed. For change details, review the revision history included in any revised document.

11.4 Community Resources

The following links connect to TI community resources. Linked contents are provided "AS IS" by the respective contributors. They do not constitute TI specifications and do not necessarily reflect TI's views; see TI's [Terms of Use](#).

TI E2E™ Online Community *TI's Engineer-to-Engineer (E2E) Community*. Created to foster collaboration among engineers. At e2e.ti.com, you can ask questions, share knowledge, explore ideas and help solve problems with fellow engineers.

Design Support *TI's Design Support* Quickly find helpful E2E forums along with design support tools and contact information for technical support.

11.5 Trademarks

E2E is a trademark of Texas Instruments.

FireWire is a trademark of Apple Inc.

All other trademarks are the property of their respective owners.

11.6 Electrostatic Discharge Caution



These devices have limited built-in ESD protection. The leads should be shorted together or the device placed in conductive foam during storage or handling to prevent electrostatic damage to the MOS gates.

11.7 Glossary

SLYZ022 — *TI Glossary*.

This glossary lists and explains terms, acronyms, and definitions.

12 Mechanical, Packaging, and Orderable Information

The following pages include mechanical, packaging, and orderable information. This information is the most current data available for the designated devices. This data is subject to change without notice and revision of this document. For browser-based versions of this data sheet, refer to the left-hand navigation.

PACKAGING INFORMATION

Orderable Device	Status (1)	Package Type	Package Drawing	Pins	Package Qty	Eco Plan (2)	Lead finish/ Ball material (6)	MSL Peak Temp (3)	Op Temp (°C)	Device Marking (4/5)	Samples
HPA00782DRLR	ACTIVE	SOT-5X3	DRL	6	4000	RoHS & Green	NIPDAUAG	Level-1-260C-UNLIM	-40 to 85	(2C7, 2CR) (2CG, 2CH)	Samples
TPD4E001DBVR	ACTIVE	SOT-23	DBV	6	3000	RoHS & Green	NIPDAU SN	Level-1-260C-UNLIM	-40 to 85	(NFY5, NFYF) (NFYP, NFYS)	Samples
TPD4E001DCKR	ACTIVE	SC70	DCK	6	3000	RoHS & Green	NIPDAU	Level-1-260C-UNLIM	-40 to 85	(2CF, 2CR) (2CP, 2CP) 2CH	Samples
TPD4E001DPKR	ACTIVE	USON	DPK	6	5000	RoHS & Green	NIPDAU	Level-1-260C-UNLIM	-40 to 85	2C7	Samples
TPD4E001DPKT	ACTIVE	USON	DPK	6	250	RoHS & Green	NIPDAU	Level-1-260C-UNLIM	-40 to 85	2C7	Samples
TPD4E001DRLR	ACTIVE	SOT-5X3	DRL	6	4000	RoHS & Green	NIPDAU NIPDAUAG	Level-1-260C-UNLIM	-40 to 85	(2C7, 2CR) (2CG, 2CH)	Samples
TPD4E001DRLRG4	ACTIVE	SOT-5X3	DRL	6	4000	RoHS & Green	NIPDAUAG	Level-1-260C-UNLIM	-40 to 85	(2C7, 2CR) (2CG, 2CH)	Samples
TPD4E001DRSR	ACTIVE	SON	DRS	6	1000	RoHS & Green	NIPDAU	Level-2-260C-1 YEAR	-40 to 85	ZWM	Samples
TPD4E001RDBVR	ACTIVE	SOT-23	DBV	6	3000	RoHS & Green	SN	Level-1-260C-UNLIM	-40 to 85	NRYF	Samples

(1) The marketing status values are defined as follows:

ACTIVE: Product device recommended for new designs.

LIFEBUY: TI has announced that the device will be discontinued, and a lifetime-buy period is in effect.

NRND: Not recommended for new designs. Device is in production to support existing customers, but TI does not recommend using this part in a new design.

PREVIEW: Device has been announced but is not in production. Samples may or may not be available.

OBSELETE: TI has discontinued the production of the device.

(2) **RoHS:** TI defines "RoHS" to mean semiconductor products that are compliant with the current EU RoHS requirements for all 10 RoHS substances, including the requirement that RoHS substance do not exceed 0.1% by weight in homogeneous materials. Where designed to be soldered at high temperatures, "RoHS" products are suitable for use in specified lead-free processes. TI may reference these types of products as "Pb-Free".

RoHS Exempt: TI defines "RoHS Exempt" to mean products that contain lead but are compliant with EU RoHS pursuant to a specific EU RoHS exemption.

Green: TI defines "Green" to mean the content of Chlorine (Cl) and Bromine (Br) based flame retardants meet JS709B low halogen requirements of <=1000ppm threshold. Antimony trioxide based flame retardants must also meet the <=1000ppm threshold requirement.

(3) MSL, Peak Temp. - The Moisture Sensitivity Level rating according to the JEDEC industry standard classifications, and peak solder temperature.

(4) There may be additional marking, which relates to the logo, the lot trace code information, or the environmental category on the device.

(5) Multiple Device Markings will be inside parentheses. Only one Device Marking contained in parentheses and separated by a "~" will appear on a device. If a line is indented then it is a continuation of the previous line and the two combined represent the entire Device Marking for that device.

(6) Lead finish/Ball material - Orderable Devices may have multiple material finish options. Finish options are separated by a vertical ruled line. Lead finish/Ball material values may wrap to two lines if the finish value exceeds the maximum column width.

Important Information and Disclaimer:The information provided on this page represents TI's knowledge and belief as of the date that it is provided. TI bases its knowledge and belief on information provided by third parties, and makes no representation or warranty as to the accuracy of such information. Efforts are underway to better integrate information from third parties. TI has taken and continues to take reasonable steps to provide representative and accurate information but may not have conducted destructive testing or chemical analysis on incoming materials and chemicals. TI and TI suppliers consider certain information to be proprietary, and thus CAS numbers and other limited information may not be available for release.

In no event shall TI's liability arising out of such information exceed the total purchase price of the TI part(s) at issue in this document sold by TI to Customer on an annual basis.

OTHER QUALIFIED VERSIONS OF TPD4E001 :

- Automotive: [TPD4E001-Q1](#)

NOTE: Qualified Version Definitions:

- Automotive - Q100 devices qualified for high-reliability automotive applications targeting zero defects

TAPE AND REEL INFORMATION



QUADRANT ASSIGNMENTS FOR PIN 1 ORIENTATION IN TAPE



*All dimensions are nominal

Device	Package Type	Package Drawing	Pins	SPQ	Reel Diameter (mm)	Reel Width W1 (mm)	A0 (mm)	B0 (mm)	K0 (mm)	P1 (mm)	W (mm)	Pin1 Quadrant
TPD4E001DBVR	SOT-23	DBV	6	3000	178.0	9.0	3.23	3.17	1.37	4.0	8.0	Q3
TPD4E001DCKR	SC70	DCK	6	3000	180.0	8.4	2.41	2.41	1.2	4.0	8.0	Q3
TPD4E001DCKR	SC70	DCK	6	3000	178.0	9.0	2.4	2.5	1.2	4.0	8.0	Q3
TPD4E001DPKR	USON	DPK	6	5000	180.0	9.5	1.75	1.75	0.7	4.0	8.0	Q2
TPD4E001DPKT	USON	DPK	6	250	180.0	9.5	1.75	1.75	0.7	4.0	8.0	Q2
TPD4E001DRLR	SOT-5X3	DRL	6	4000	180.0	8.4	1.98	1.78	0.69	4.0	8.0	Q3
TPD4E001DRSR	SON	DRS	6	1000	330.0	12.4	3.3	3.3	1.1	8.0	12.0	Q2
TPD4E001RDBVR	SOT-23	DBV	6	3000	178.0	9.0	3.23	3.17	1.37	4.0	8.0	Q3

TAPE AND REEL BOX DIMENSIONS

*All dimensions are nominal

Device	Package Type	Package Drawing	Pins	SPQ	Length (mm)	Width (mm)	Height (mm)
TPD4E001DBVR	SOT-23	DBV	6	3000	180.0	180.0	18.0
TPD4E001DCKR	SC70	DCK	6	3000	183.0	183.0	20.0
TPD4E001DCKR	SC70	DCK	6	3000	180.0	180.0	18.0
TPD4E001DPKR	USON	DPK	6	5000	184.0	184.0	19.0
TPD4E001DPKT	USON	DPK	6	250	184.0	184.0	19.0
TPD4E001DRLR	SOT-5X3	DRL	6	4000	183.0	183.0	20.0
TPD4E001DRSR	SON	DRS	6	1000	853.0	449.0	35.0
TPD4E001RDBVR	SOT-23	DBV	6	3000	180.0	180.0	18.0

EXAMPLE BOARD LAYOUT

DRL0006A

SOT - 0.6 mm max height

PLASTIC SMALL OUTLINE

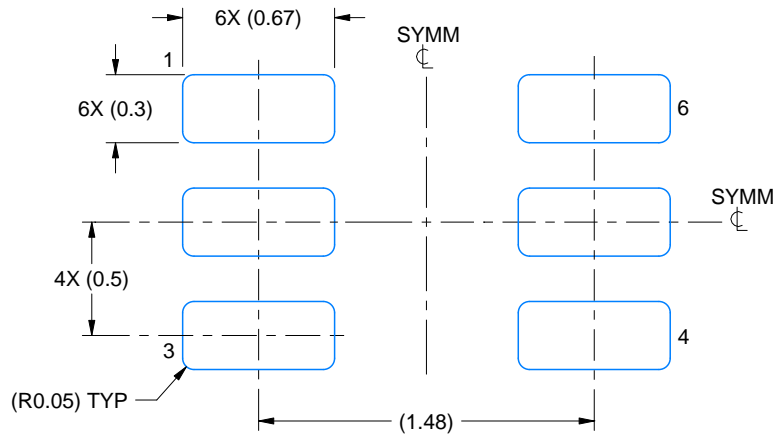

LAND PATTERN EXAMPLE
SCALE:30X

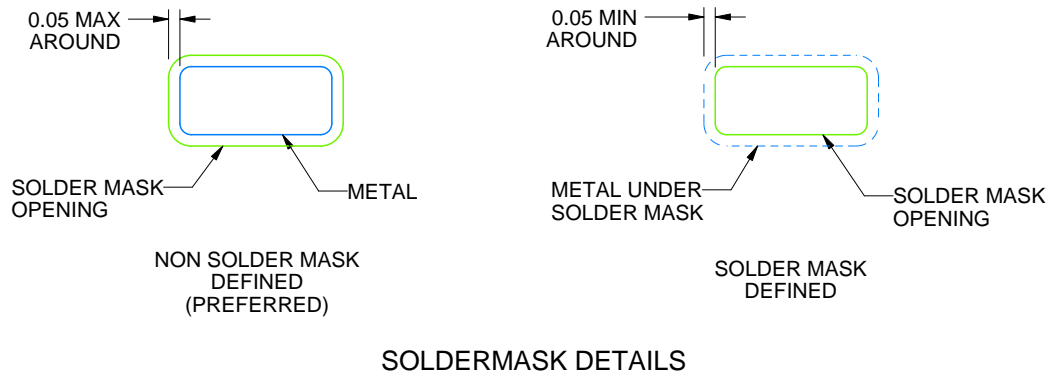

SOLDERMASK DETAILS

4223266/B 12/2020

NOTES: (continued)

- 5. Publication IPC-7351 may have alternate designs.
- 6. Solder mask tolerances between and around signal pads can vary based on board fabrication site.

EXAMPLE STENCIL DESIGN

DRL0006A

SOT - 0.6 mm max height

PLASTIC SMALL OUTLINE

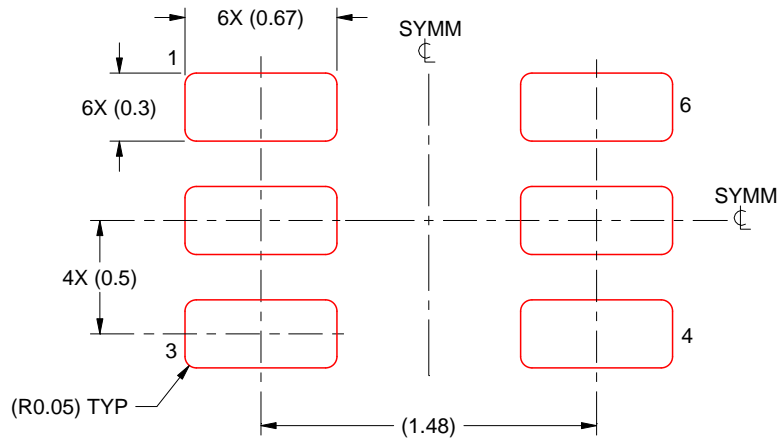

SOLDER PASTE EXAMPLE
BASED ON 0.1 mm THICK STENCIL
SCALE:30X

4223266/B 12/2020

NOTES: (continued)

7. Laser cutting apertures with trapezoidal walls and rounded corners may offer better paste release. IPC-7525 may have alternate design recommendations.
8. Board assembly site may have different recommendations for stencil design.

DRS (S-PWSON-N6)

PLASTIC SMALL OUTLINE NO-LEAD

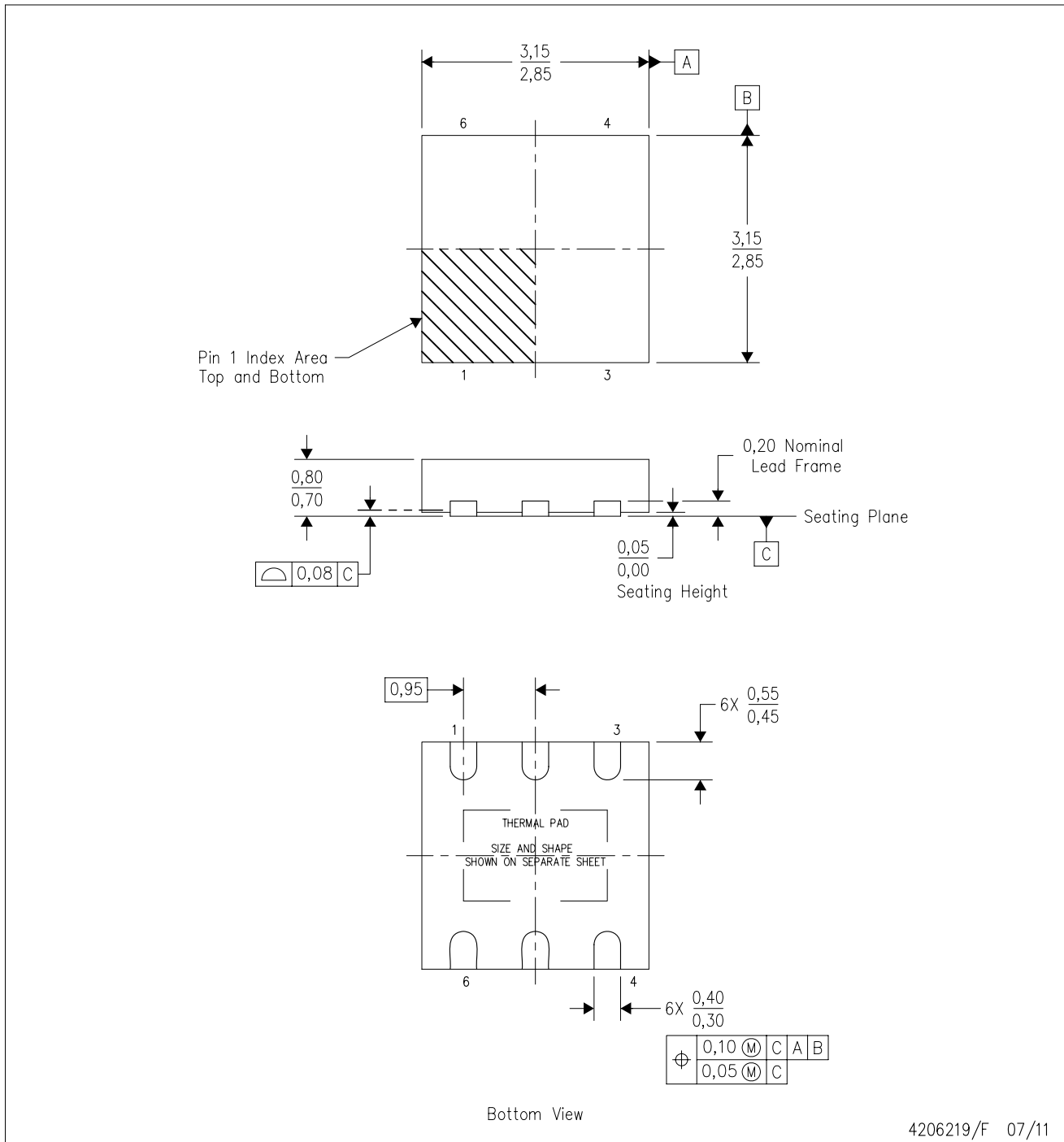

- NOTES:
- All linear dimensions are in millimeters. Dimensioning and tolerancing per ASME Y14.5M-1994.
 - This drawing is subject to change without notice.
 - SON (Small Outline No-Lead) package configuration.
 - The package thermal pad must be soldered to the board for thermal and mechanical performance.
 - See the additional figure in the Product Data Sheet for details regarding the exposed thermal pad features and dimensions.

THERMAL PAD MECHANICAL DATA

DRS (S-PWSON-N6)

PLASTIC SMALL OUTLINE NO-LEAD

THERMAL INFORMATION

This package incorporates an exposed thermal pad that is designed to be attached directly to an external heatsink. The thermal pad must be soldered directly to the printed circuit board (PCB). After soldering, the PCB can be used as a heatsink. In addition, through the use of thermal vias, the thermal pad can be attached directly to the appropriate copper plane shown in the electrical schematic for the device, or alternatively, can be attached to a special heatsink structure designed into the PCB. This design optimizes the heat transfer from the integrated circuit (IC).

For information on the Quad Flatpack No-Lead (QFN) package and its advantages, refer to Application Report, QFN/SON PCB Attachment, Texas Instruments Literature No. SLUA271. This document is available at www.ti.com.

The exposed thermal pad dimensions for this package are shown in the following illustration.

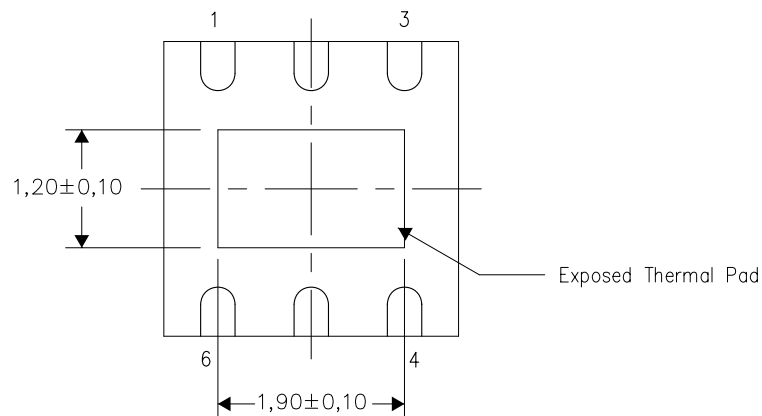

Bottom View

Exposed Thermal Pad Dimensions

4207663/E 07/11

NOTE: All linear dimensions are in millimeters

DRS (S-PWSON-N6)

PLASTIC SMALL OUTLINE NO-LEAD

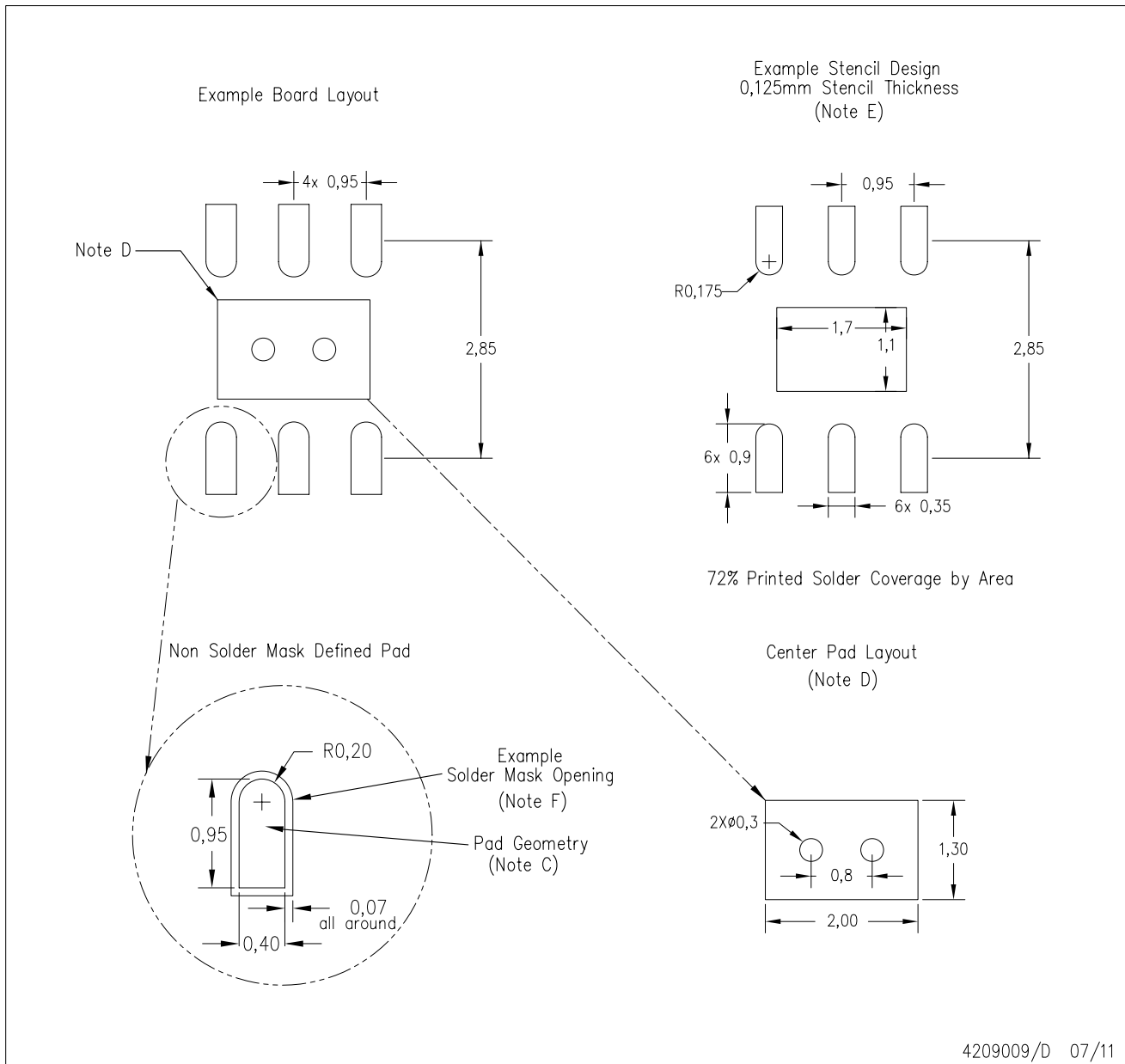

- NOTES:
- A. All linear dimensions are in millimeters.
 - B. This drawing is subject to change without notice.
 - C. Publication IPC-7351 is recommended for alternate designs.
 - D. This package is designed to be soldered to a thermal pad on the board. Refer to Application Note, QFN/SON PCB Attachment, Texas Instruments Literature No. SLUA271, and also the Product Data Sheets for specific thermal information, via requirements, and recommended board layout. These documents are available at www.ti.com <<http://www.ti.com>>.
 - E. Laser cutting apertures with trapezoidal walls and also rounding corners will offer better paste release. Customers should contact their board assembly site for stencil design recommendations. Refer to IPC 7525 for stencil design considerations.
 - F. Customers should contact their board fabrication site for solder mask tolerances.

DCK (R-PDSO-G6)

PLASTIC SMALL OUTLINE



- NOTES:
- A. All linear dimensions are in millimeters.
 - B. This drawing is subject to change without notice.
 - C. Customers should place a note on the circuit board fabrication drawing not to alter the center solder mask defined pad.
 - D. Publication IPC-7351 is recommended for alternate designs.
 - E. Laser cutting apertures with trapezoidal walls and also rounding corners will offer better paste release. Customers should contact their board assembly site for stencil design recommendations. Example stencil design based on a 50% volumetric metal load solder paste. Refer to IPC-7525 for other stencil recommendations.

DBV0006A



PACKAGE OUTLINE

SOT-23 - 1.45 mm max height

SMALL OUTLINE TRANSISTOR

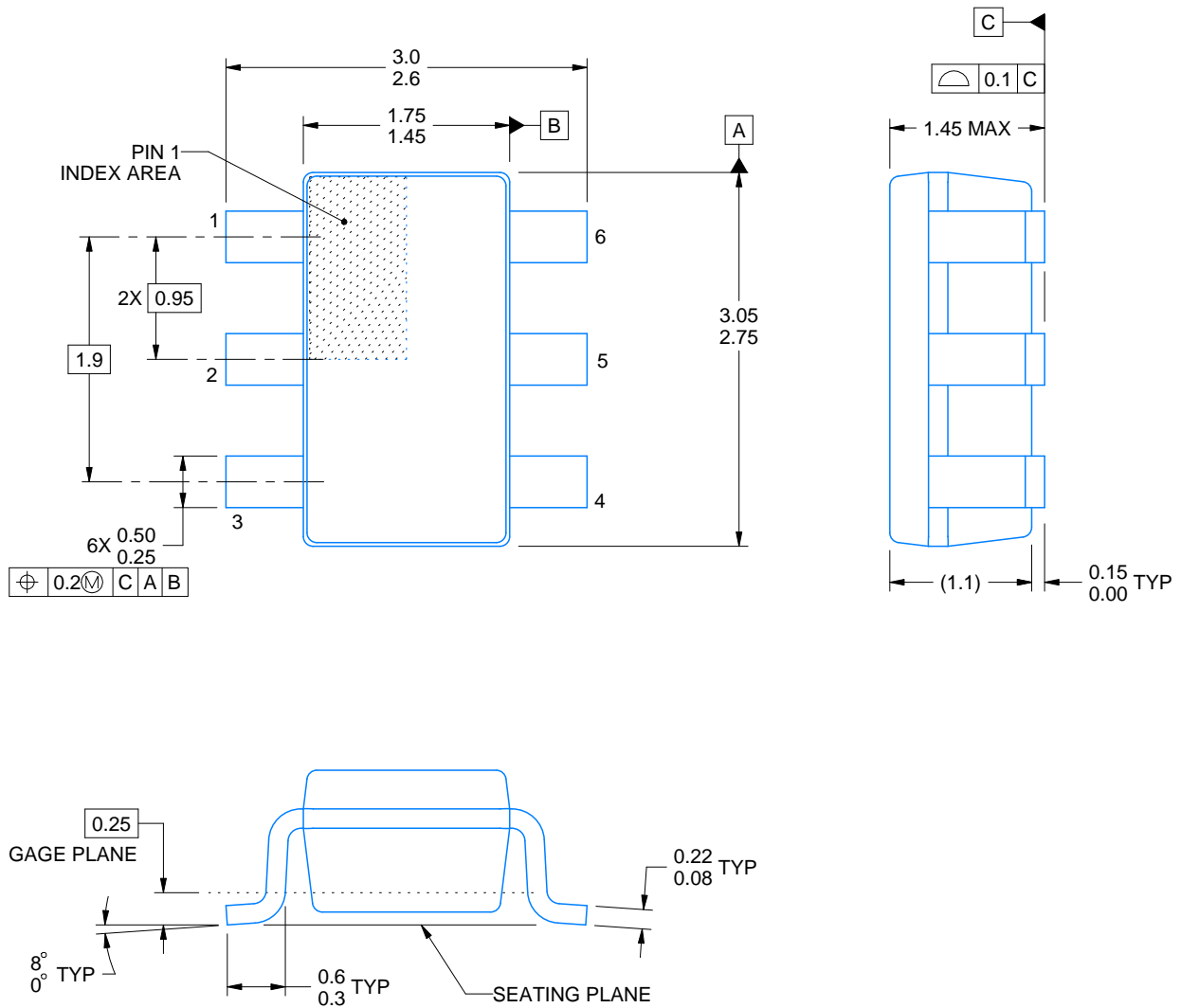

4214840/C 06/2021

NOTES:

1. All linear dimensions are in millimeters. Any dimensions in parenthesis are for reference only. Dimensioning and tolerancing per ASME Y14.5M.
2. This drawing is subject to change without notice.
3. Body dimensions do not include mold flash or protrusion. Mold flash and protrusion shall not exceed 0.25 per side.
4. Leads 1,2,3 may be wider than leads 4,5,6 for package orientation.
5. Reference JEDEC MO-178.

EXAMPLE BOARD LAYOUT

DBV0006A

SOT-23 - 1.45 mm max height

SMALL OUTLINE TRANSISTOR



LAND PATTERN EXAMPLE
EXPOSED METAL SHOWN
SCALE:15X



SOLDER MASK DETAILS

4214840/C 06/2021

NOTES: (continued)

- 6. Publication IPC-7351 may have alternate designs.
- 7. Solder mask tolerances between and around signal pads can vary based on board fabrication site.

EXAMPLE STENCIL DESIGN

DBV0006A

SOT-23 - 1.45 mm max height

SMALL OUTLINE TRANSISTOR



SOLDER PASTE EXAMPLE
BASED ON 0.125 mm THICK STENCIL
SCALE:15X

4214840/C 06/2021

NOTES: (continued)

8. Laser cutting apertures with trapezoidal walls and rounded corners may offer better paste release. IPC-7525 may have alternate design recommendations.
9. Board assembly site may have different recommendations for stencil design.

DPK (S-PUSON-N6)

PLASTIC SMALL OUTLINE NO-LEAD

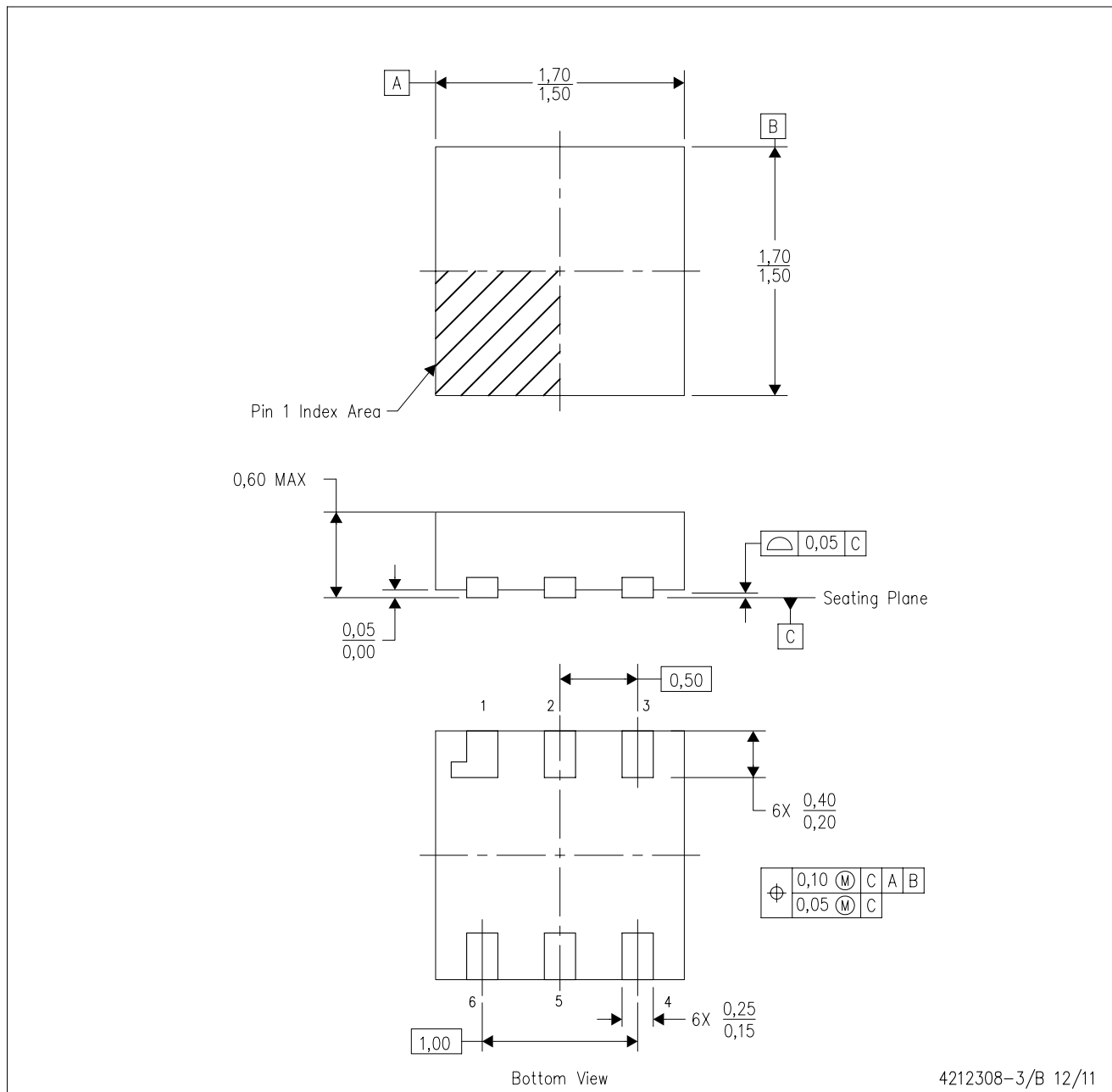

4212308-3/B 12/11

NOTES: A. All linear dimensions are in millimeters. Dimensioning and tolerancing per ASME Y14.5M-1994.
 B. This drawing is subject to change without notice.

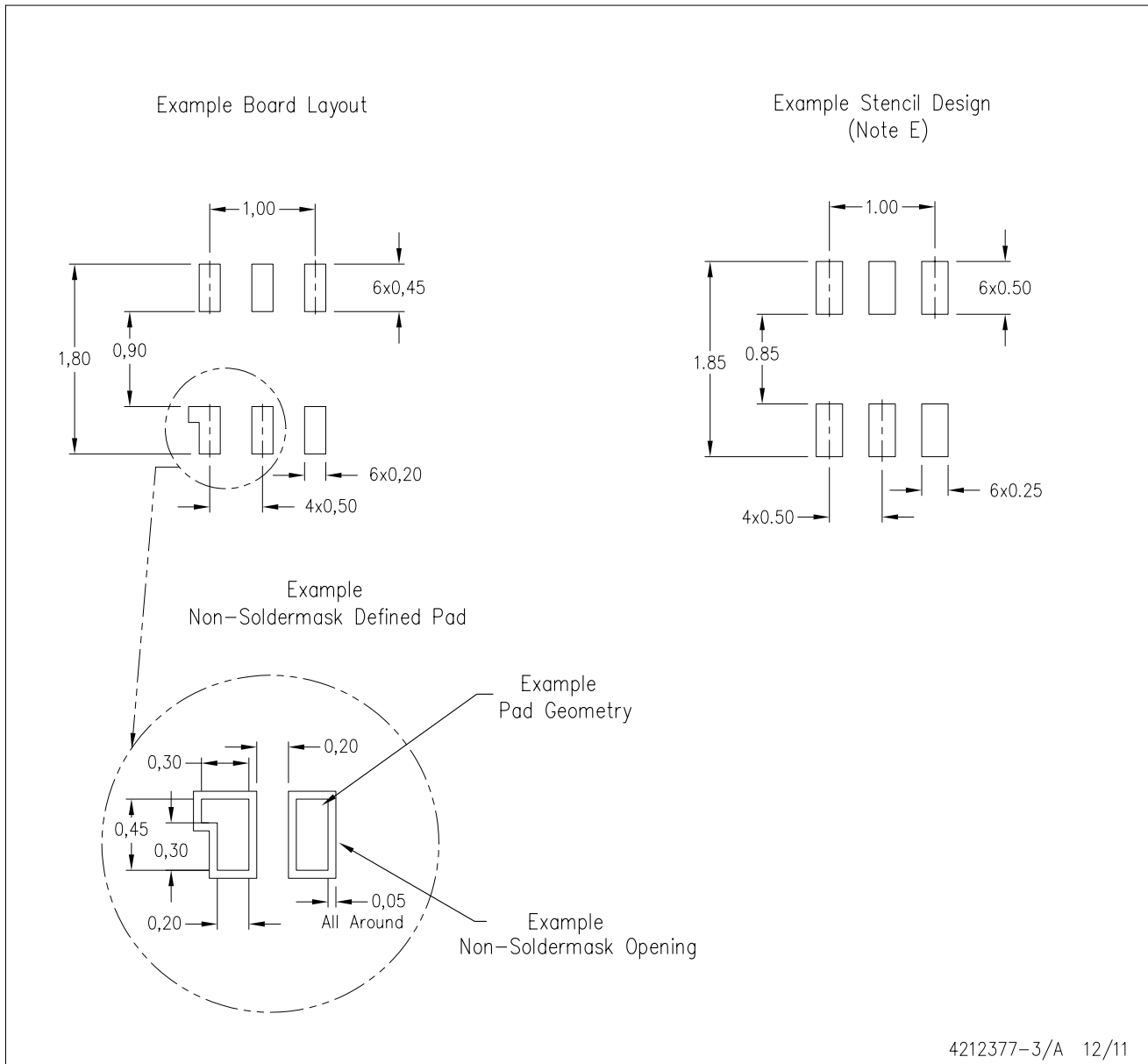

- NOTES:
- All linear dimensions are in millimeters.
 - This drawing is subject to change without notice.
 - Publication IPC-7351 is recommended for alternate designs.
 - Customers should contact their board fabrication site for minimum solder mask web tolerances between signal pads.
 - Maximum stencil thickness 0,127 mm (5 mils). All linear dimensions are in millimeters.
 - Laser cutting apertures with trapezoidal walls and also rounding corners will offer better paste release. Customers should contact their board assembly site for stencil design recommendations. Refer to IPC 7525 for stencil design considerations.
 - Side aperture dimensions over-print land for acceptable area ratio > 0.66. Customer may reduce side aperture dimensions if stencil manufacturing process allows for sufficient release at smaller opening.

IMPORTANT NOTICE AND DISCLAIMER

TI PROVIDES TECHNICAL AND RELIABILITY DATA (INCLUDING DATASHEETS), DESIGN RESOURCES (INCLUDING REFERENCE DESIGNS), APPLICATION OR OTHER DESIGN ADVICE, WEB TOOLS, SAFETY INFORMATION, AND OTHER RESOURCES "AS IS" AND WITH ALL FAULTS, AND DISCLAIMS ALL WARRANTIES, EXPRESS AND IMPLIED, INCLUDING WITHOUT LIMITATION ANY IMPLIED WARRANTIES OF MERCHANTABILITY, FITNESS FOR A PARTICULAR PURPOSE OR NON-INFRINGEMENT OF THIRD PARTY INTELLECTUAL PROPERTY RIGHTS.

These resources are intended for skilled developers designing with TI products. You are solely responsible for (1) selecting the appropriate TI products for your application, (2) designing, validating and testing your application, and (3) ensuring your application meets applicable standards, and any other safety, security, or other requirements. These resources are subject to change without notice. TI grants you permission to use these resources only for development of an application that uses the TI products described in the resource. Other reproduction and display of these resources is prohibited. No license is granted to any other TI intellectual property right or to any third party intellectual property right. TI disclaims responsibility for, and you will fully indemnify TI and its representatives against, any claims, damages, costs, losses, and liabilities arising out of your use of these resources.

TI's products are provided subject to TI's Terms of Sale (<https://www.ti.com/legal/termsofsale.html>) or other applicable terms available either on [ti.com](https://www.ti.com) or provided in conjunction with such TI products. TI's provision of these resources does not expand or otherwise alter TI's applicable warranties or warranty disclaimers for TI products.

Mailing Address: Texas Instruments, Post Office Box 655303, Dallas, Texas 75265
Copyright © 2021, Texas Instruments Incorporated