

GLASS PASSIVATED SUPER FAST RECTIFIER

FEATURES

- High Performance & Reliability best suited for Automotive application
- Plastic package has Underwriters Laboratory Flammability Classification 94V-0
- Fast switching for high efficiency
- Low forward voltage drop Single rectifier construction
- High surge capability
- For use in low voltage ,high frequency inverters, free wheeling, and polarity protection applications
- High temperature soldering guaranteed: 260 °C/10 seconds, 0.25”(6.35mm) from case
- Component in accordance to RoHS 2002/95/EC and WEEE 2002/96/EC

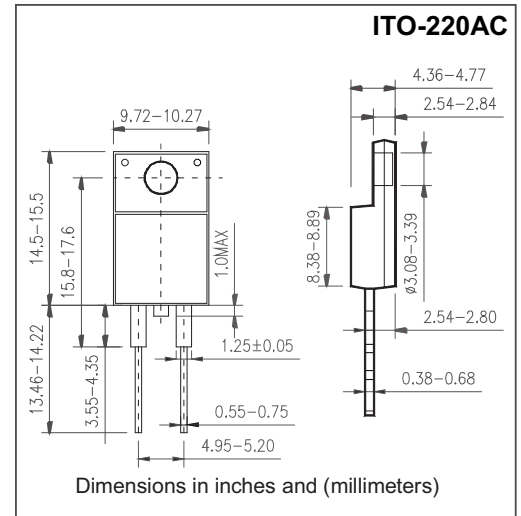

MECHANICAL DATA

- Case: JEDEC ITO-220AC molded plastic body
- Terminals: Lead solderable per MIL-STD-750,method 2026
- Polarity: As marked
- Mounting Position: Any
- Weight: 0.08ounce, 2.24 gram

MAXIMUM RATINGS AND ELECTRICAL CHARACTERISTICS

- Ratings at 25 °C ambient temperature unless otherwise specified, Single phase, half wave, resistive or inductive load.
For capacitive load,derate by 20%.

	Symbols	MURF 860	Units
Maximum repetitive peak reverse voltage	V_{RRM}	600	Volts
Maximum RMS voltage	V_{RMS}	420	Volts
Maximum DC blocking voltage	V_{DC}	600	Volts
Maximum average forward rectified	$I_{(AV)}$	8.0	Amp
Peak forward surge current 8.3ms single half sine-wave superimposed on rated load (JEDEC method)	I_{FSM}	125	Amps
Maximum Instantaneous Forward Voltage at 8.0 A	V_F	1.5	Volts
Maximum instantaneous reverse current at rated DC blocking voltage(Note 1)	$T_a=25\text{ }^\circ\text{C}$	5	μA
	$T_a=125\text{ }^\circ\text{C}$	500	
Maximum reverse recovery time(Note1)	T_{RR}	35	ns
Typical thermal resistance (Note2)	$R_{\theta JC}$	2.5	pF
Operating junction and storage temperature range	T_J / T_{STG}	-65 to +175	$^\circ\text{C}$

Notes:

1. Pulse test: 300 μs pulse width, 1% duty cycle
2. Reverse recovery test conditions $I_F = 0.5\text{A}$, $I_R = 1.0\text{A}$, $I_{RR} = 0.5\text{A}$
3. Thermal resistance from junction to case

GLASS PASSIVATED SUPER FAST RECTIFIER

RATINGS AND CHARACTERISTIC CURVES MURF860

FIG.1-FORWARD CURRENT DERATING CURVE

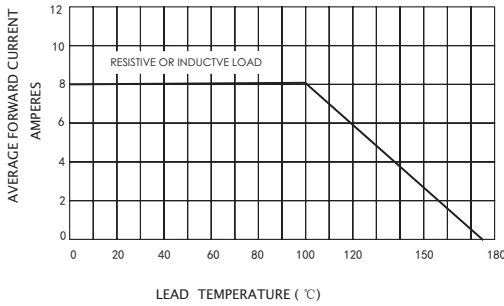

FIG.2-MAXIMUM NON-REPETITIVE PEAK FORWARD SURGE CURRENT

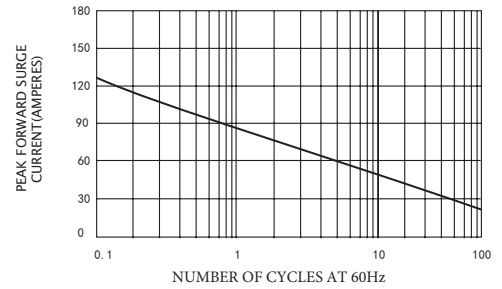

FIG.3-TYPICAL INSTANTANEOUS FORWARD CHARACTERISTICS

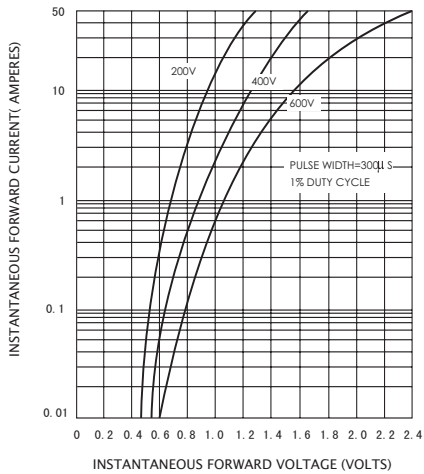

FIG.4-TYPICAL REVERSE CHARACTERISTICS

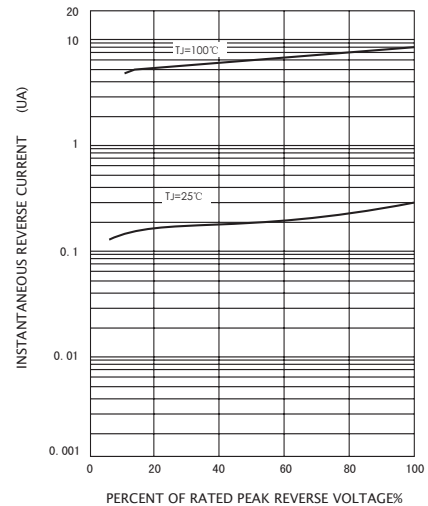

FIG.5-TYPICAL JUNCTION CAPACITANCE

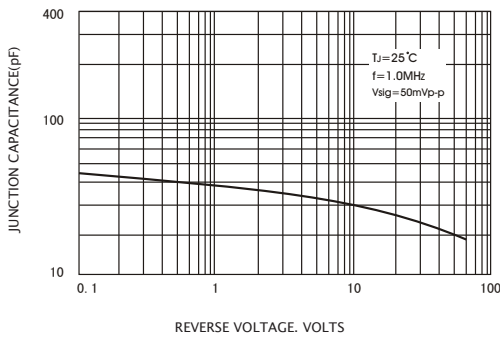
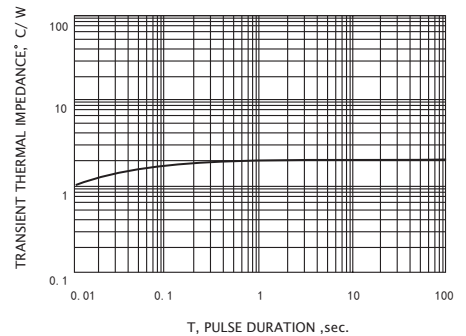

FIG.6-TYPICAL TRANSIENT THERMAL IMPEDANCE



Disclaimer

All product, product specifications and data are subject to change without notice to improve reliability, function or design or otherwise.