



## TO-92 Plastic-Encapsulate Transistors

### MPSA42 TRANSISTOR

#### (NPN)FEATURES

- High voltage

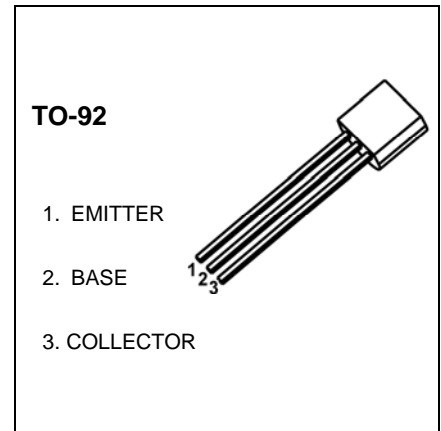

#### MARKING

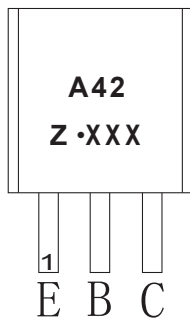

A42=Device code  
 Solid dot=Green molding compound device,  
 if none,the normal device  
 Z=Rank of  $h_{FE}$   
 XXX=Code

#### Equivalent Circuit

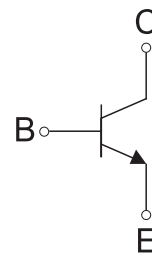

#### ORDERING INFORMATION

Part Number	Package	Packing Method	Pack Quantity
MPSA42	TO-92	Bulk	1000pcs/Bag
MPSA42-TA	TO-92	Tape	2000pcs/Box

#### MAXIMUM RATINGS ( $T_a=25^{\circ}\text{C}$ unless otherwise noted)

Symbol	Parameter	Value	Unit
$V_{CBO}$	Collector-Base Voltage	310	V
$V_{CEO}$	Collector-Emitter Voltage	305	V
$V_{EBO}$	Emitter-Base Voltage	5	V
$I_C$	Collector Current -Continuous	200	mA
$I_{CM}$	Collector Current - Pulsed	500	mA
$P_C$	Collector Power Dissipation	625	mW
$T_J, T_{stg}$	Operation Junction and Storage Temperature Range	-55-150	$^{\circ}\text{C}$
$R_{\theta JA}$	Thermal Resistance, junction to Ambient	200	$^{\circ}\text{C} / \text{W}$

## ELECTRICAL CHARACTERISTICS

$T_a=25^\circ\text{C}$  unless otherwise specified

Parameter	Symbol	Test conditions	Min	Typ	Max	Unit
Collector-base breakdown voltage	$V_{(BR)CBO}$	$I_C=100\mu\text{A}, I_E=0$	310			V
Collector-emitter breakdown voltage	$V_{(BR)CEO}$	$I_C=1\text{mA}, I_B=0$	305			V
Emitter-base breakdown voltage	$V_{(BR)EBO}$	$I_E=100\mu\text{A}, I_C=0$	5			V
Collector cut-off current	$I_{CBO}$	$V_{CB}=200\text{V}, I_E=0$			0.25	$\mu\text{A}$
Emitter cut-off current	$I_{EBO}$	$V_{EB}=5\text{V}, I_C=0$			0.1	$\mu\text{A}$
DC current gain	$h_{FE(1)}$	$V_{CE}=10\text{V}, I_C=1\text{mA}$	60			
	$h_{FE(2)}$	$V_{CE}=10\text{V}, I_C=10\text{mA}$	80		250	
	$h_{FE(3)}$	$V_{CE}=10\text{V}, I_C=30\text{mA}$	75			
Collector-emitter saturation voltage	$V_{CE(sat)}$	$I_C=20\text{mA}, I_B=2\text{mA}$			0.2	V
Base-emitter saturation voltage	$V_{BE(sat)}$	$I_C=20\text{mA}, I_B=2\text{mA}$			0.9	V
Transition frequency	$f_T$	$V_{CE}=20\text{V}, I_C=10\text{mA}, f=30\text{MHz}$	50			MHz

### CLASSIFICATION OF $h_{FE(2)}$

Rank	A	B	C
Range	80-100	100-200	200-250

# Typical Characteristics

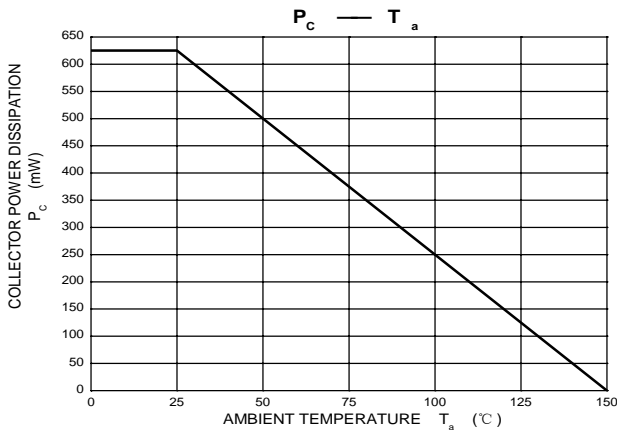
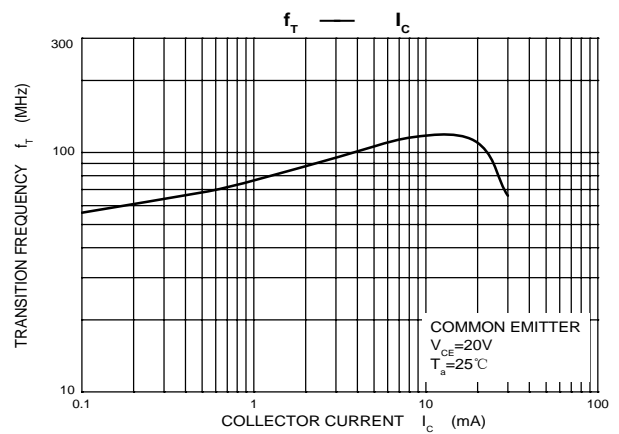
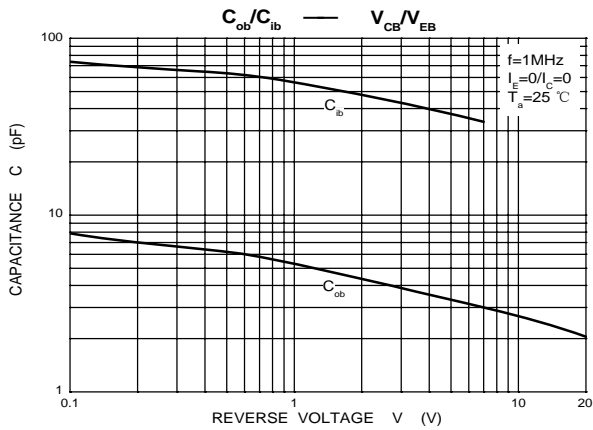
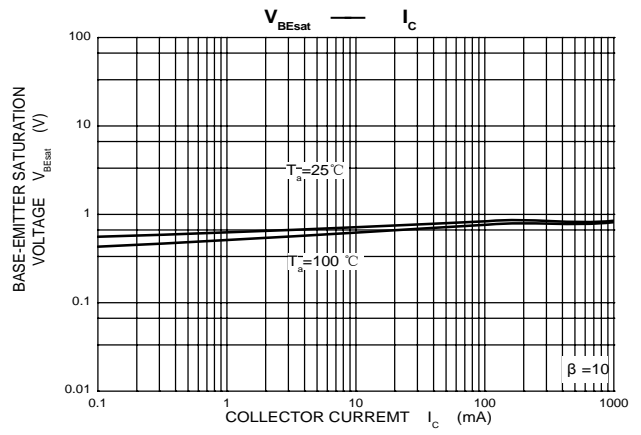
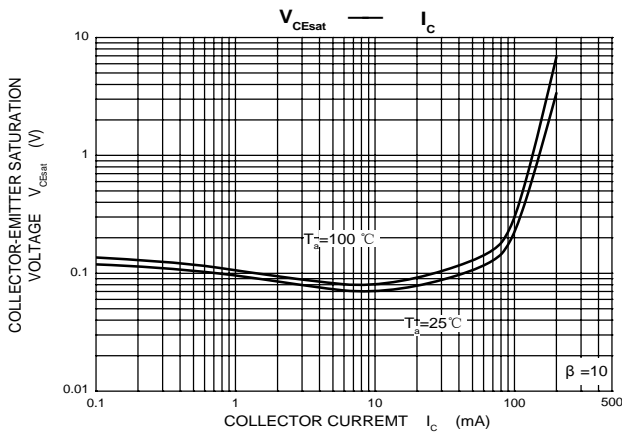
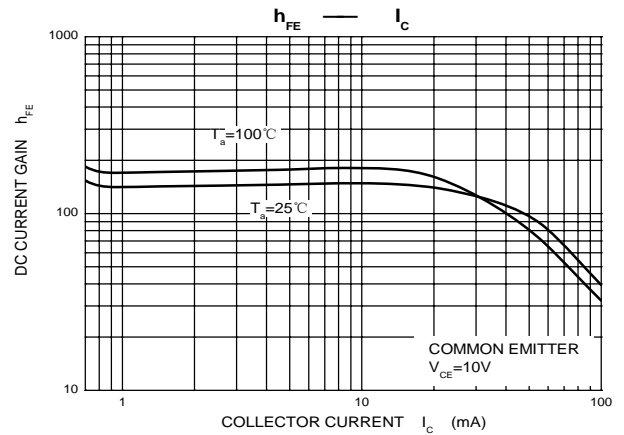
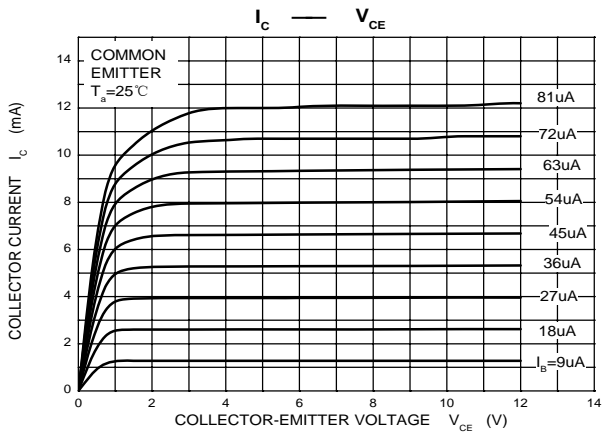

## TO-92 Package Outline Dimensions

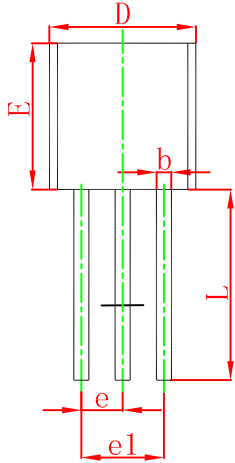
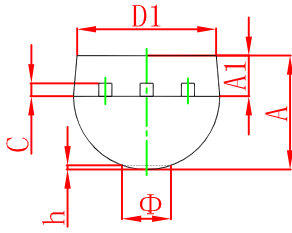

Symbol	Dimensions In Millimeters		Dimensions In Inches	
	Min	Max	Min	Max
A	3.300	3.700	0.130	0.146
A1	1.100	1.400	0.043	0.055
b	0.380	0.550	0.015	0.022
c	0.360	0.510	0.014	0.020
D	4.300	4.700	0.169	0.185
D1	3.430		0.135	
E	4.300	4.700	0.169	0.185
e	1.270 TYP		0.050 TYP	
e1	2.440	2.640	0.096	0.104
L	14.100	14.500	0.555	0.571
Φ		1.600		0.063
h	0.000	0.380	0.000	0.015

## TO-92 Suggested Pad Layout

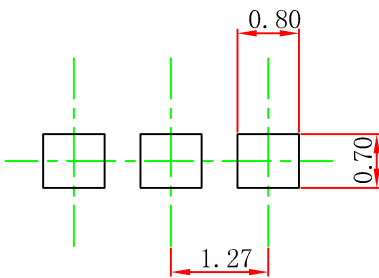

### Note:

1. Controlling dimension: in millimeters.
2. General tolerance:  $\pm 0.05$ mm.
3. The pad layout is for reference purposes only.

### NOTICE

JSCJ reserves the right to make modifications, enhancements, improvements, corrections or other changes without further notice to any product herein. JSCJ does not assume any liability arising out of the application or use of any product described herein.

TO-92 PACKAGE TAPING DIMENSION

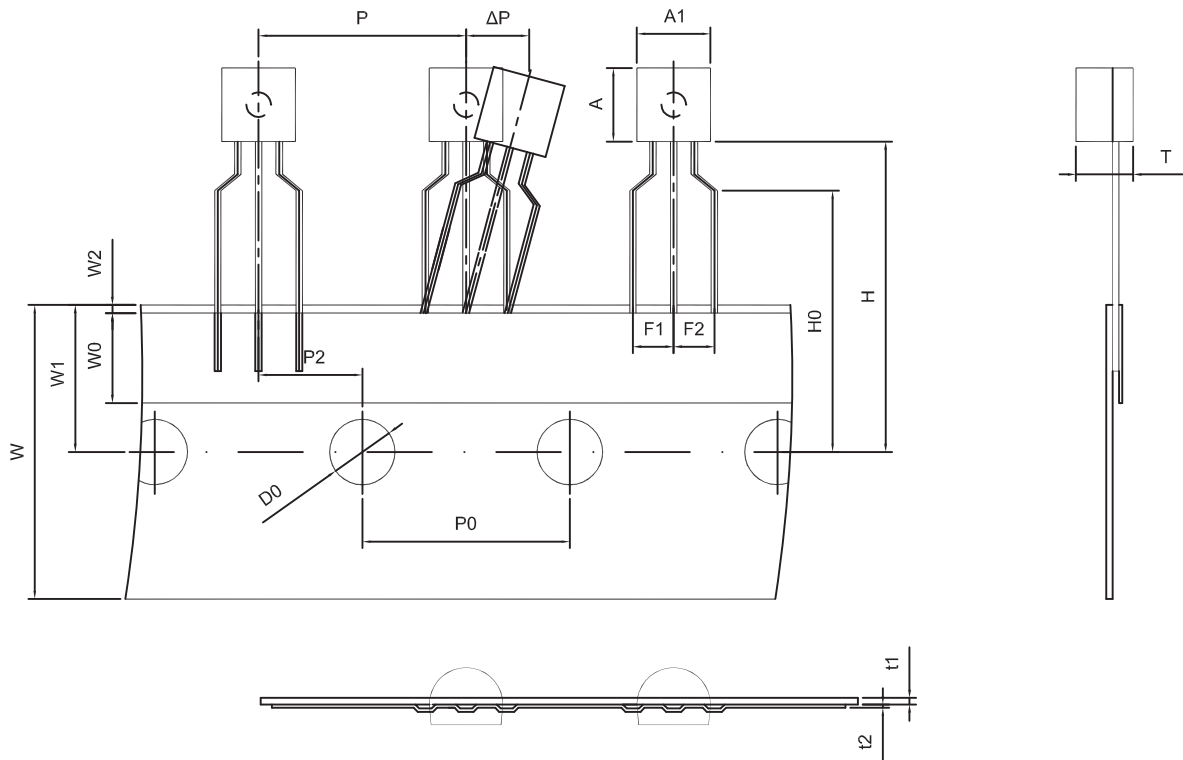

Dimensions are in millimeter

A1	A	T	P	P0	P2	F1	F2	W
4.5	4.5	3.5	12.7	12.7	6.35	2.5	2.5	18.0
W0	W1	W2	H	H0	D0	t1	t2	ΔP
6.0	9.0	1.0 MAX.	19.0	16.0	4.0	0.4	0.2	0

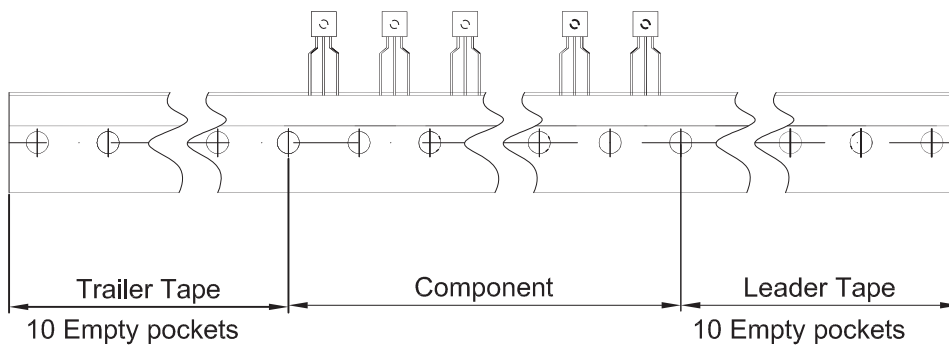

Package	Box	Box Size(mm)	Carton	Carton Size(mm)
TO-92	2000 pcs	333×162×43	20,000 pcs	350×340×250