

FEATURES

- Proprietary New Planar Technology
- $R_{DS(ON)}$, typ.=50m Ω @VGS=10V
- Low Gate Charge Minimize Switching Loss
- Fast Recovery Body Diode

APPLICATIONS

- DC-DC Converters
- DC-AC Inverters for UPS
- SMPS and Motor controls

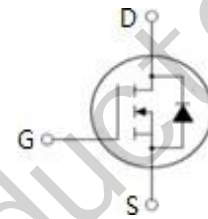

Absolute Maximum Ratings $T_C = 25^\circ\text{C}$, unless otherwise noted			
Parameter	Symbol	Value	Unit
		TO-220	
Drain-Source Voltage	V_{DSS}	200	V
Continuous Drain Current	I_D	50	A
Pulsed Drain Current (note1)	I_{DM}	180	A
Gate-Source Voltage	V_{GSS}	± 20	V
Single Pulse Avalanche Energy (note1)	E_{AS}	191	mJ
Avalanche Current (note1)	I_{AS}	31	A
Repetitive Avalanche Energy (note1)	E_{AR}	124	mJ
Power Dissipation ($T_C = 25^\circ\text{C}$)	P_D	104	W
Operating Junction and Storage Temperature Range	T_J, T_{stg}	-55~+150	$^\circ\text{C}$

Thermal Resistance				
Parameter	Symbol	Value		Unit
			TO-220	
Thermal Resistance, Junction-to-Case	R_{thJC}		1.2	$^\circ\text{C/W}$
Thermal Resistance, Junction-to-Ambient	R_{thJA}		60	

Specifications $T_J = 25^\circ\text{C}$, unless otherwise noted						
Parameter	Symbol	Test Conditions	Value			Unit
			Min.	Typ.	Max.	
Static						
Drain-Source Breakdown Voltage	$V_{(BR)DSS}$	$V_{GS} = 0V, I_D = 250\mu A$	200	--	--	V
Zero Gate Voltage Drain Current	I_{DSS}	$V_{DS} = 200V, V_{GS} = 0V, T_J = 25^\circ\text{C}$	--	--	1	μA
		$V_{DS} = 200V, V_{GS} = 0V, T_J = 125^\circ\text{C}$	--	--	100	
Gate-Source Leakage	I_{GSS}	$V_{GS} = \pm 20V, V_{DS} = 0V$	--	--	± 100	nA
Gate-Source Threshold Voltage	$V_{GS(th)}$	$V_{DS} = V_{GS}, I_D = 250\mu A$	2.0	--	4.0	V
Drain-Source On-Resistance (Note4)	$R_{DS(on)}$	$V_{GS} = 10V, I_D = 20A$	--	0.035	0.05	Ω
Forward Transconductance (Note4)	gfs	$V_{DS} = 25V, I_D = 20A$	--	16	--	S
Dynamic						
Input Capacitance	C_{iss}	$V_{GS} = 0V, V_{DS} = 25V, f = 1.0\text{MHz}$	--	2800	--	μF
Output Capacitance	C_{oss}		--	355	--	
Reverse Transfer Capacitance	C_{rss}		--	101	--	
Total Gate Charge	Q_g	$V_{DD} = 160V, I_D = 40A,$	--	154	--	nC
Gate-Source Charge	Q_{gs}		--	13	--	
Gate-Drain Charge	Q_{gd}		--	58	--	
Turn-on Delay Time	$t_{d(on)}$	$V_{DD} = 160V, I_D = 40A, V_{GS} = 15V, R_G = 25\Omega$	--	46	--	ns
Turn-on Rise Time	t_r		--	54	--	
Turn-off Delay Time	$t_{d(off)}$		--	360	--	
Turn-off Fall Time	t_f		--	96	--	
Drain-Source Body Diode Characteristics						
Continuous Source Current	I_{SD}	Integral PN-diode in MOSFET	--	--	50	A
Pulsed Source Current	I_{SM}		--	--	180	
Body Forward Voltage	V_{SD}	$I_S = 20A, V_{GS} = 0V$	--	--	1.4	V
Reverse Recovery Time	t_{rr}	$V_{GS} = 0V, I_F = 10A, di_F/dt = 100A/\mu s$	--	152	--	ns
Reverse Recovery Charge	Q_{rr}		--	1	--	μC

Notes:

1. Repetitive Rating: Pulse width limited by maximum junction temperature
2. $L = 1\text{mH}, V_{DD} = 30V, R_G = 25\Omega$, Starting $T_J = 25^\circ\text{C}$
3. Pulse Test: Pulse width $\leq 300\mu s$, Duty Cycle $\leq 1\%$

Typical Characteristics $T_J = 25^\circ\text{C}$, unless otherwise noted

Figure 1. Output Characteristics ($T_J = 25^\circ\text{C}$)

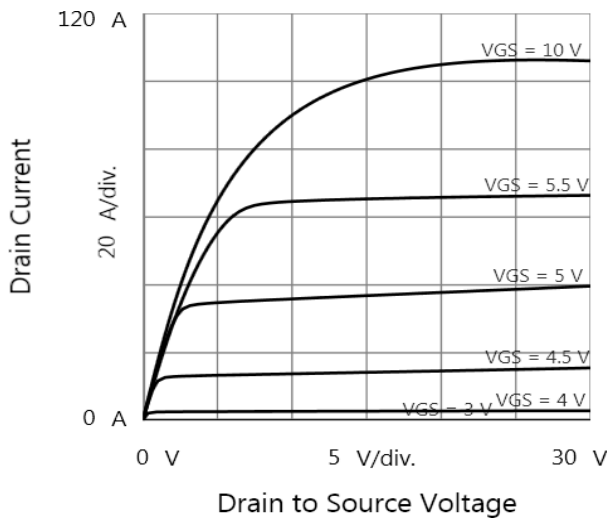

Figure 2. Transfer Characteristics

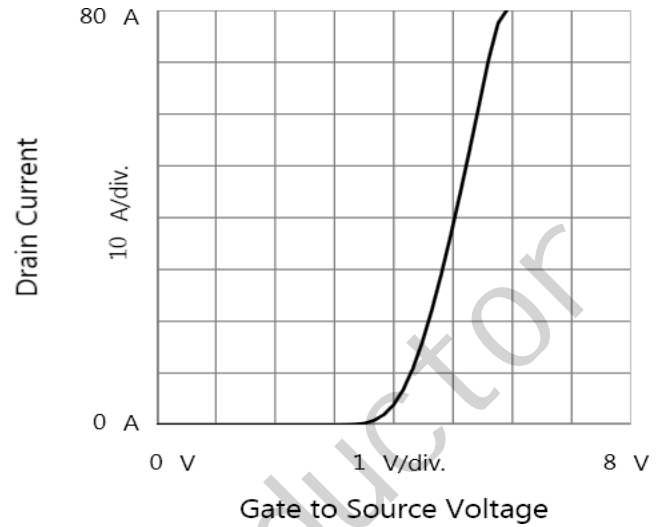

Figure 3. Drain to Source Resistance vs. Drain Current

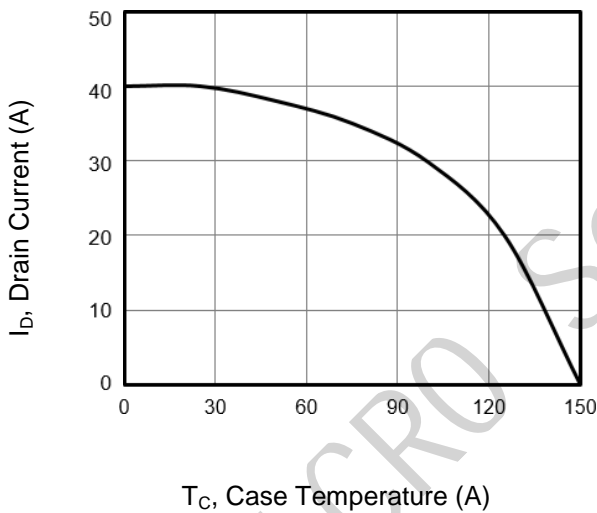

Figure 4. BV_{DSS} Variation vs. Temperature

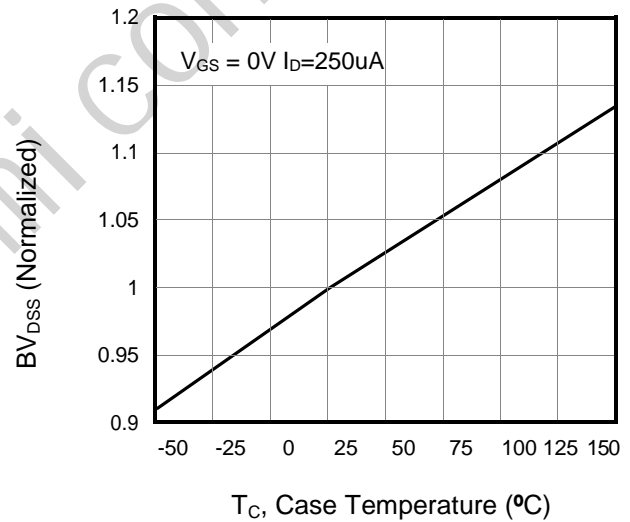

Figure 5. Drain to Source Voltage vs. Gate to Source Voltage

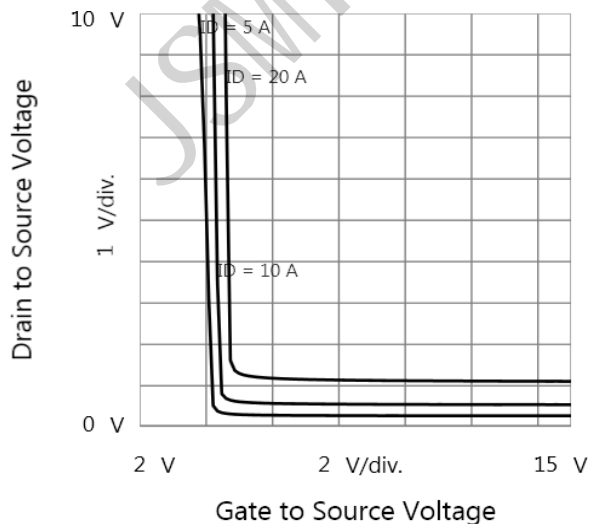
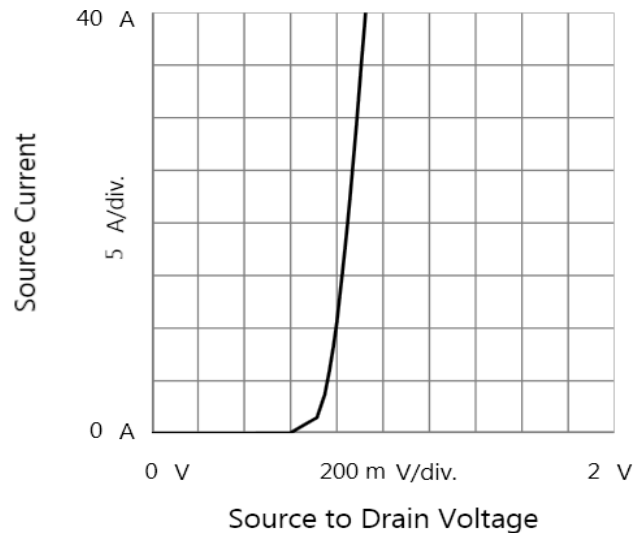

Figure 6. Body Diode Forward Characteristics



Typical Characteristics $T_J = 25^\circ\text{C}$, unless otherwise noted

Figure 7. Capacitance

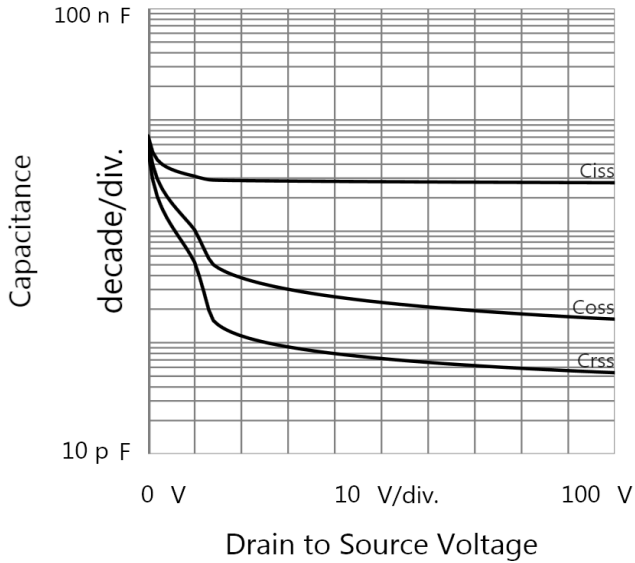

Figure 8. Gate Charge

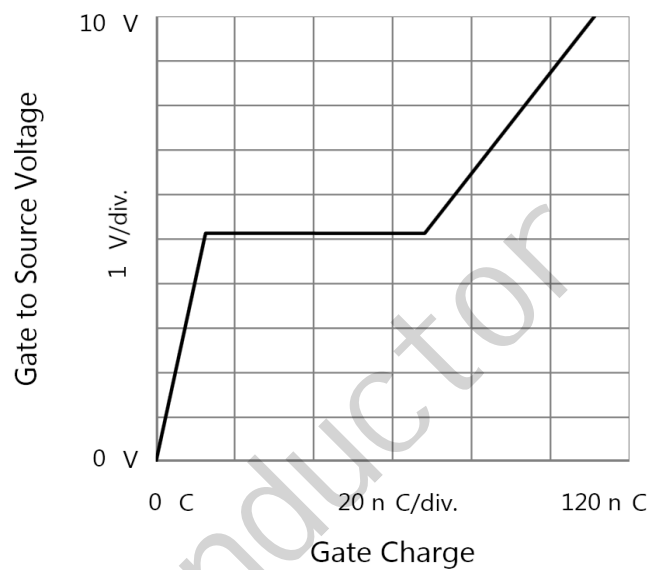

Figure 9. Transient Thermal Impedance TO-220

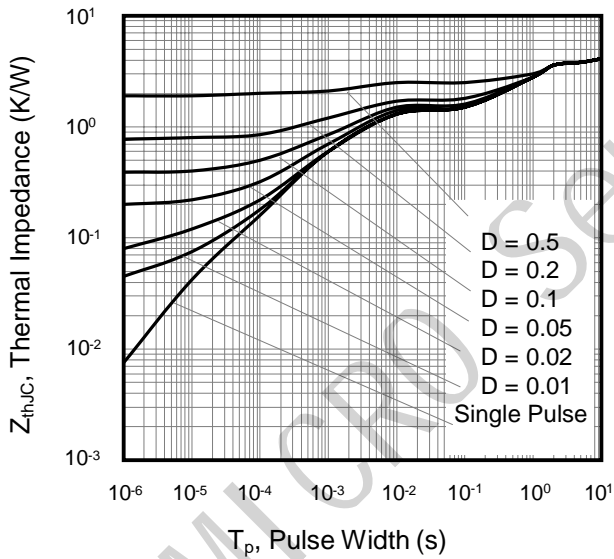

Figure 10. Transient Thermal Impedance TO-220

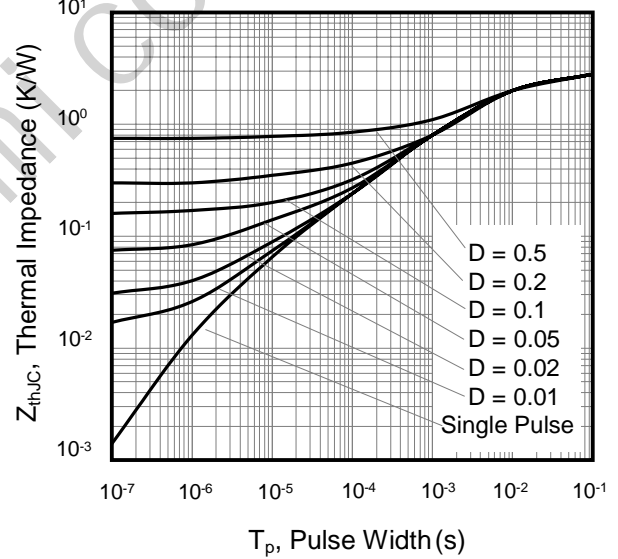

Figure A: Gate Charge Test Circuit and Waveform

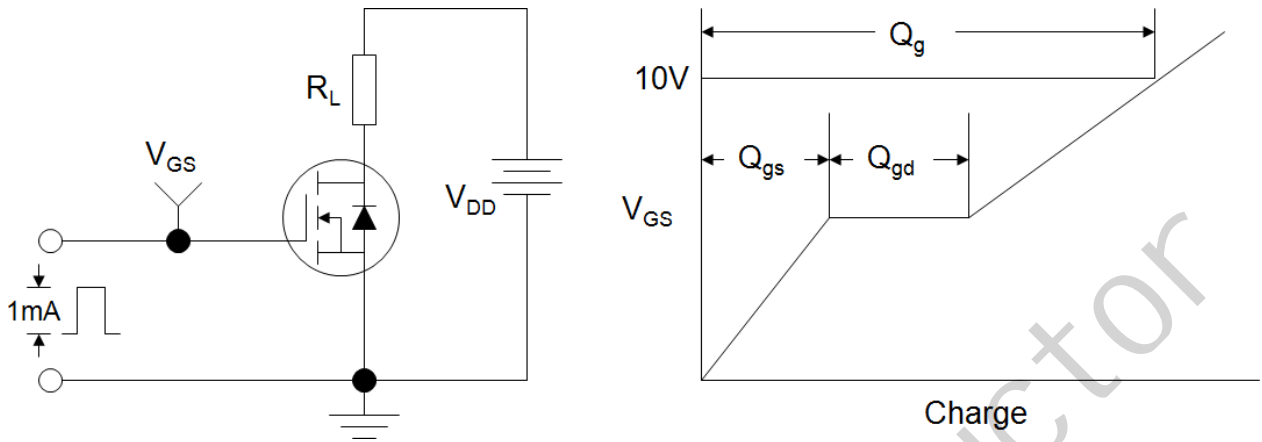

Figure B: Resistive Switching Test Circuit and Waveform

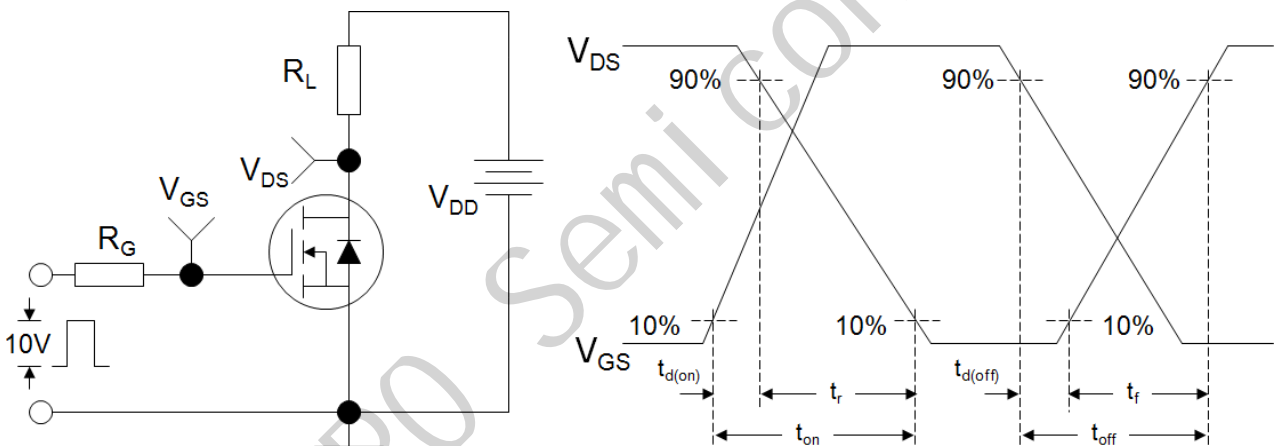
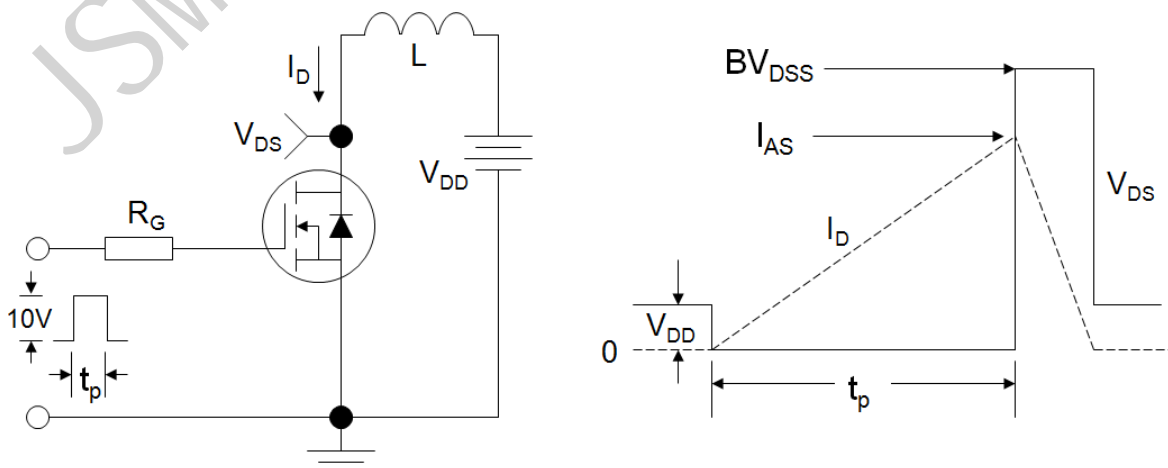
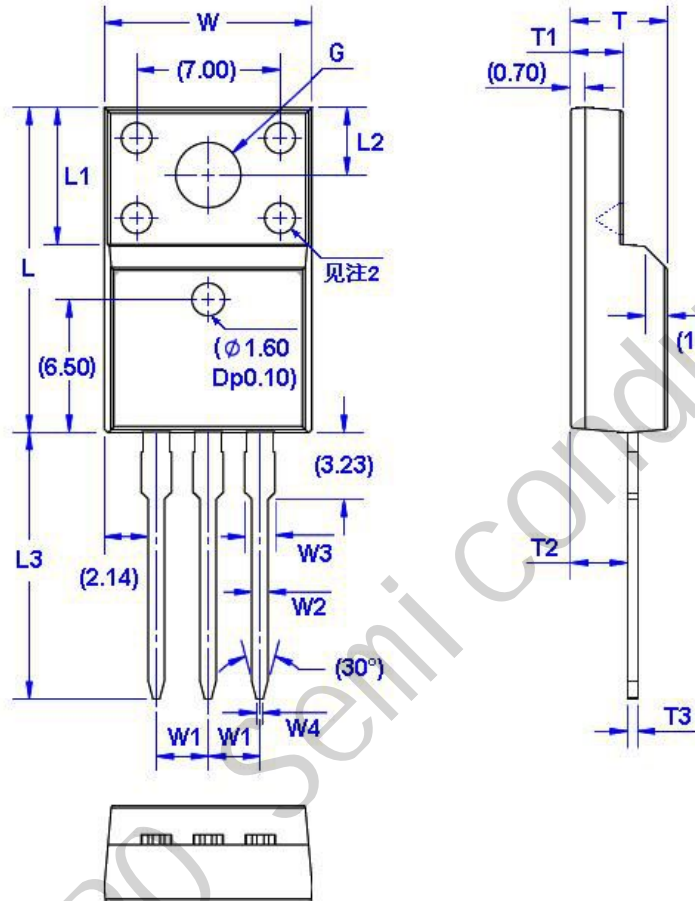

Figure C: Unclamped Inductive Switching Test Circuit and Waveform



Package Outline: TO-220



Symbol	Size		Symbol	Size		Symbol	Size		Symbol	Size	
	Min	Max		Min	Max		Min	Max		Min	Max
W	9.96	10.36	W4	0.25	0.45	L3	12.78	13.18	T3	0.45	0.60
W1	2.54 (TYP)		L	15.67	16.07	T	4.50	4.90	G(Φ)	3.08	3.28
W2	0.70	0.90	L1	6.48	6.88	T1	2.34	2.74			
W3	1.24	1.47	L2	3.20	3.40	T2	2.56	2.96			