

Description:

This P-Channel MOSFET uses advanced trench technology and design to provide excellent $R_{DS(on)}$ with low gate charge. It can be used in a wide variety of applications.

Features:

- 1) $V_{DS}=-60V, I_D=-17A, R_{DS(ON)}<86m\Omega @V_{GS}=-10V$
- 2) Low gate charge.
- 3) Green device available.
- 4) Advanced high cell density trench technology for ultra $R_{DS(ON)}$.
- 5) Excellent package for good heat dissipation.

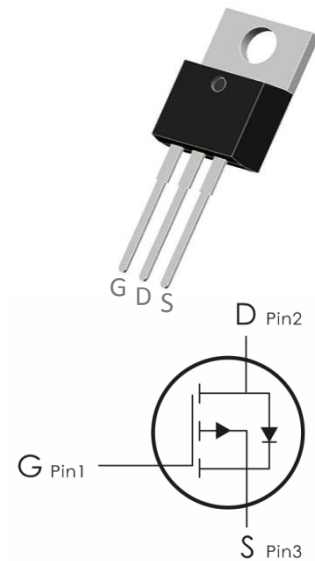

Absolute Maximum Ratings: ($T_C=25^\circ C$ unless otherwise noted)

Symbol	Parameter	Ratings	Units
V_{DS}	Drain-Source Voltage	-60	V
V_{GS}	Gate-Source Voltage	± 20	V
I_D	Continuous Drain Current	-17	A
	Continuous Drain Current-TC=100°C	---	
	Pulsed Drain Current ¹	-76	
E_{AS}	Single Pulse Avalanche Energy	---	mJ
P_D	Power Dissipation(TC=25°C)	50	W
T_J, T_{STG}	Operating and Storage Junction Temperature Range	-55 to +150	°C

Thermal Characteristics:

Symbol	Parameter	Max	Units
$R_{\theta JC}$	Thermal Resistance,Junction to Case	3	°C/W
$R_{\theta JA}$	Thermal Resistance,Junction to Ambient	62.5	

Electrical Characteristics: ($T_C=25^\circ\text{C}$ unless otherwise noted)

Symbol	Parameter	Conditions	Min	Typ	Max	Units
Off Characteristics						
BV_{DSS}	Drain-Source Breakdown Voltage	$V_{GS}=0V, I_D=-250\ \mu\text{A}$	-60	---	---	V
I_{DSS}	Zero Gate Voltage Drain Current	$V_{GS}=0V, V_{DS}=-60V$	---	---	-1	μA
I_{GSS}	Gate-Source Leakage Current	$V_{GS}=\pm 20V, V_{DS}=0A$	---	---	± 100	nA
On Characteristics²						
$V_{GS(th)}$	GATE-Source Threshold Voltage	$V_{GS}=V_{DS}, I_D=-250\ \mu\text{A}$	-1	---	-3	V
$R_{DS(on)}$	Drain-Source On Resistance	$V_{GS}=-10V, I_D=-8A$	---	61	86	$m\ \Omega$
		$V_{GS}=-4.5V, I_D=-6A$	---	75	125	
G_{FS}	Forward Transconductance	$V_{DS}=-10V, I_D=-15A$	---	10	---	S
Dynamic Characteristics³						
C_{iss}	Input Capacitance	$V_{DS}=-30V, V_{GS}=0V, f=1\text{MHz}$	---	1135	---	μF
C_{oss}	Output Capacitance		---	95	---	
C_{rss}	Reverse Transfer Capacitance		---	60	---	
Switching Characteristics³						
$t_{d(on)}$	Turn-On Delay Time	$V_{DD}=-30V, I_D=-1A,$ $R_{GEN}=6\ \Omega, V_{GS}=-10V$	---	13	26	ns
t_r	Rise Time		---	4	8	ns
$t_{d(off)}$	Turn-Off Delay Time		---	45	90	ns
t_f	Fall Time		---	6	12	ns
Q_g	Total Gate Charge	$V_{GS}=-10V, V_{DS}=-30V,$ $I_D=-3.5A$	---	22.6	29.4	nC
Q_{gs}	Gate-Source Charge		---	2.4	---	nC
Q_{gd}	Gate-Drain "Miller" Charge		---	5.7	---	nC
Drain-Source Diode Characteristics						
V_{SD}	Source-Drain Diode Forward Voltage ²	$V_{GS}=0V, I_S=-19A$	---	---	-1.5	V

Notes:

1. Repetitive Rating: Pulse width limited by maximum junction temperature.
2. Pulse Test: Pulse Width $\leq 300\mu\text{s}$, Duty Cycle $\leq 2\%$.
3. Guaranteed by design, not subject to production.

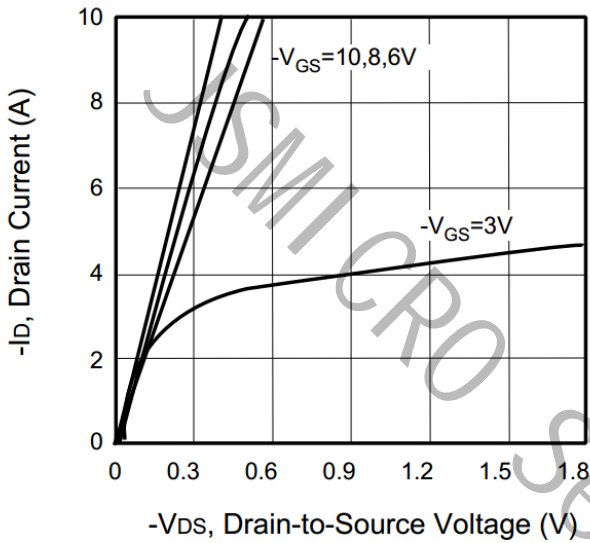
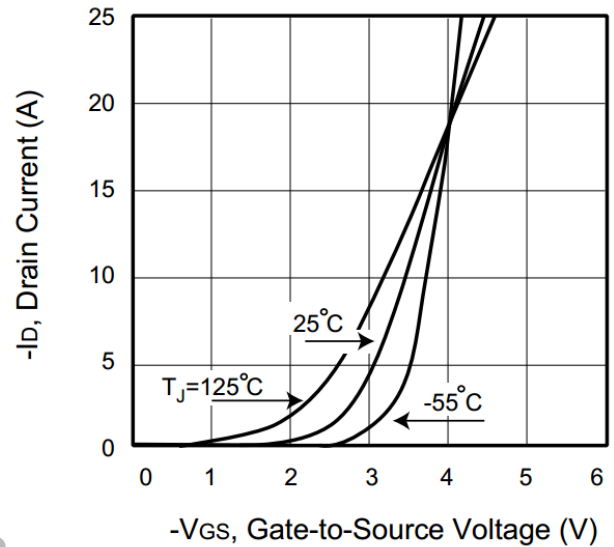
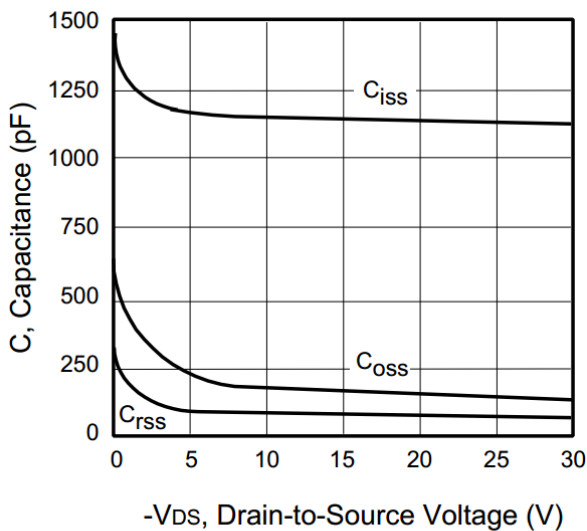
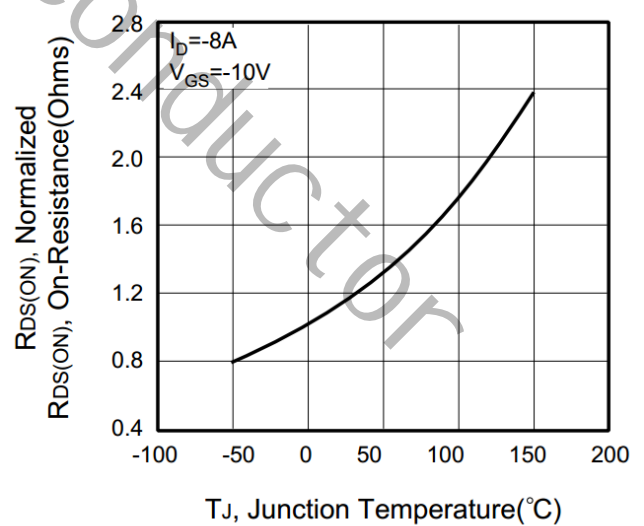
Typical Characteristics: ($T_c=25^\circ\text{C}$ unless otherwise noted)

Figure 1. Output Characteristics

Figure 2. Transfer Characteristics

Figure 3. Capacitance

Figure 4. On-Resistance Variation with Temperature

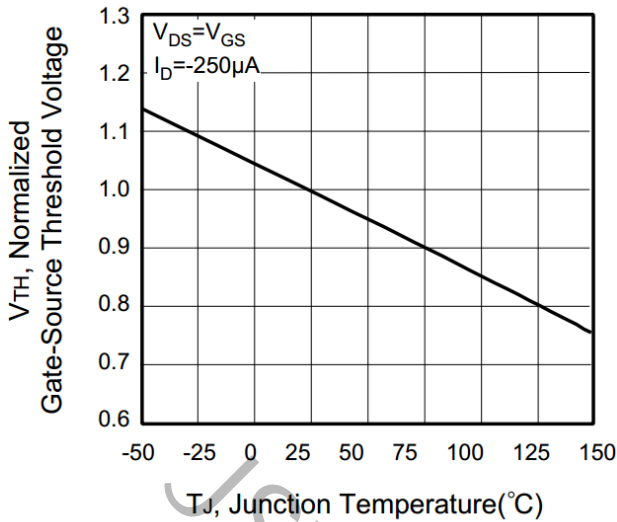

Figure 5. Gate Threshold Variation with Temperature

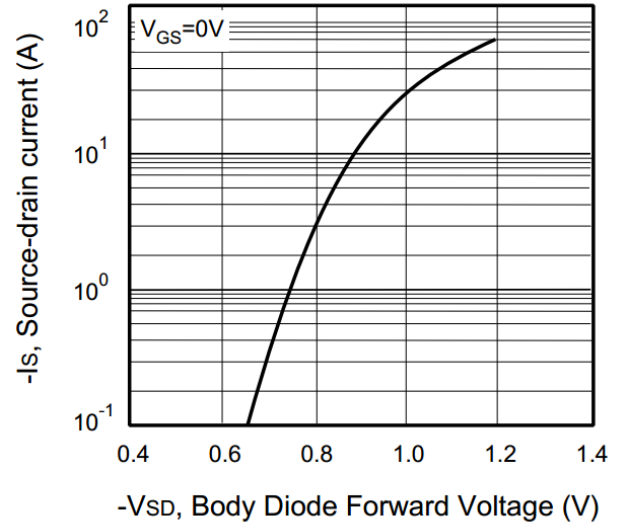

Figure 6. Body Diode Forward Voltage Variation with Source Current

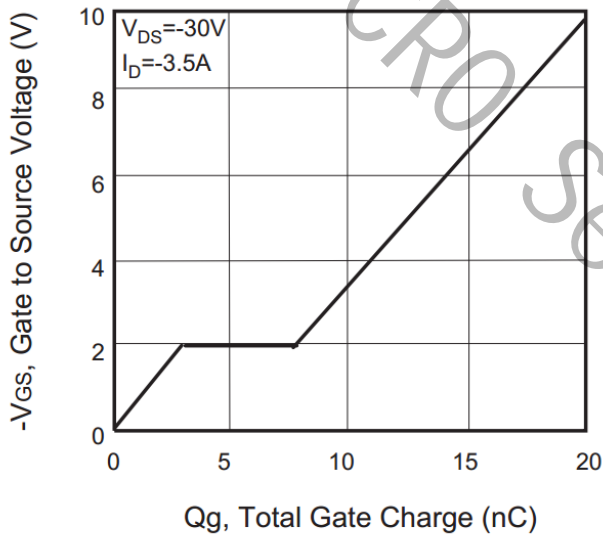

Figure 7. Gate Charge

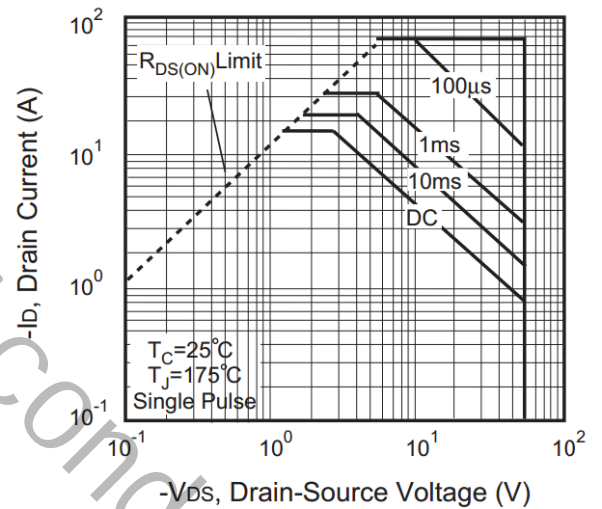

Figure 8. Maximum Safe Operating Area

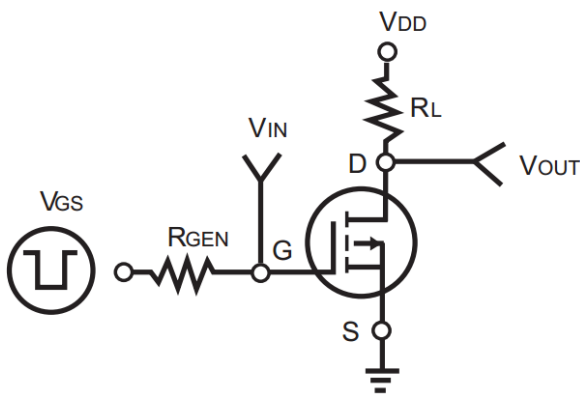

Figure 9. Switching Test Circuit

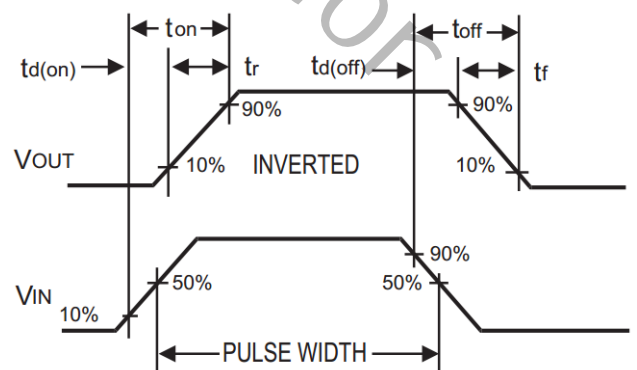

Figure 10. Switching Waveforms

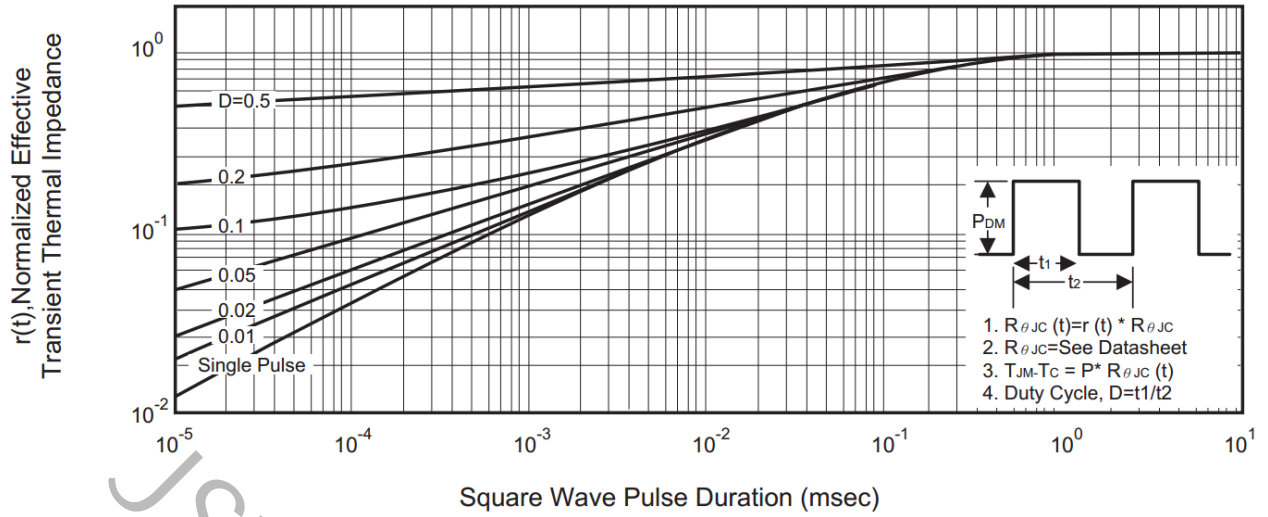

Figure 11. Normalized Thermal Transient Impedance Curve

JSMICRO Semi conductor