

FEATURES

- Fast switching
- 100% avalanche tested
- Improved dv/dt capability

APPLICATIONS

- Switch Mode Power Supply (SMPS)
- Uninterruptible Power Supply (UPS)
- Power Factor Correction (PFC)

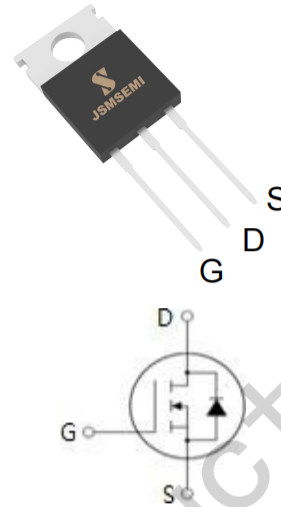

Absolute Maximum Ratings $T_C = 25^\circ\text{C}$, unless otherwise noted

Parameter	Symbol	Value	Unit
		TO-220	
Drain-Source Voltage ($V_{GS} = 0V$)	V_{DSS}	200	V
Continuous Drain Current	I_D	18	A
Pulsed Drain Current (note1)	I_{DM}	72	A
Gate-Source Voltage	V_{GSS}	± 20	V
Single Pulse Avalanche Energy (note2)	E_{AS}	262.7	mJ
Avalanche Current (note1)	I_{AS}	7.3	A
Repetitive Avalanche Energy (note1)	E_{AR}	157.62	mJ
Power Dissipation ($T_C = 25^\circ\text{C}$)	P_D	104	W
Operating Junction and Storage Temperature Range	T_J, T_{stg}	-55~+150	$^\circ\text{C}$

Thermal Resistance

Parameter	Symbol	Value	Unit
		TO-220	
Thermal Resistance, Junction-to-Case	R_{thJC}	1.2	K/W
Thermal Resistance, Junction-to-Ambient	R_{thJA}	60	

Specifications $T_J = 25^\circ\text{C}$, unless otherwise noted

Parameter	Symbol	Test Conditions	Value			Unit
			Min.	Typ.	Max.	
Static						
Drain-Source Breakdown Voltage	$V_{(BR)DSS}$	$V_{GS} = 0V, I_D = 250\mu A$	200	--	--	V
Zero Gate Voltage Drain Current	I_{DSS}	$V_{DS} = 200V, V_{GS} = 0V, T_J = 25^\circ\text{C}$	--	--	1	μA
Gate-Source Leakage	I_{GSS}	$V_{GS} = \pm 20V$	--	--	± 100	nA
Gate-Source Threshold Voltage	$V_{GS(th)}$	$V_{DS} = V_{GS}, I_D = 250\mu A$	2.0	--	4.0	V
Drain-Source On-Resistance (Note3)	$R_{DS(on)}$	$V_{GS} = 10V, I_D = 9A$	--	0.12	0.15	Ω
Dynamic						
Input Capacitance	C_{iss}	$V_{GS} = 0V,$ $V_{DS} = 25V,$ $f = 1.0\text{MHz}$	--	1200	--	pF
Output Capacitance	C_{oss}		--	161	--	
Reverse Transfer Capacitance	C_{rss}		--	70	--	
Total Gate Charge	Q_g	$V_{DD} = 160V, I_D = 18A,$ $V_{GS} = 10V$	--	38	--	nC
Gate-Source Charge	Q_{gs}		--	6	--	
Gate-Drain Charge	Q_{gd}		--	16	--	
Turn-on Delay Time	$t_{d(on)}$	$V_{DD} = 100V, I_D = 18A,$ $R_G = 25\Omega$	--	40	--	ns
Turn-on Rise Time	t_r		--	33	--	
Turn-off Delay Time	$t_{d(off)}$		--	166	--	
Turn-off Fall Time	t_f		--	60	--	
Drain-Source Body Diode Characteristics						
Continuous Body Diode Current	I_S	$T_C = 25^\circ\text{C}$	--	--	18	A
Pulsed Diode Forward Current	I_{SM}		--	--	72	
Body Diode Voltage	V_{SD}	$T_J = 25^\circ\text{C}, I_{SD} = 9A, V_{GS} = 0V$	--	--	1.4	V
Reverse Recovery Time	t_{rr}	$V_{GS} = 0V, I_S = 18A,$ $di_F/dt = 100A/\mu s$	--	182	--	ns
Reverse Recovery Charge	Q_{rr}		--	1.29	--	μC

Notes

1. Repetitive Rating: Pulse width limited by maximum junction temperature
2. $I_{AS} = 15A, V_{DD} = 50V, R_G = 25\Omega$, Starting $T_J = 25^\circ\text{C}$
3. Pulse Test: Pulse width $\leq 300\mu s$, Duty Cycle $\leq 1\%$

Typical Characteristics $T_J = 25^\circ\text{C}$, unless otherwise noted

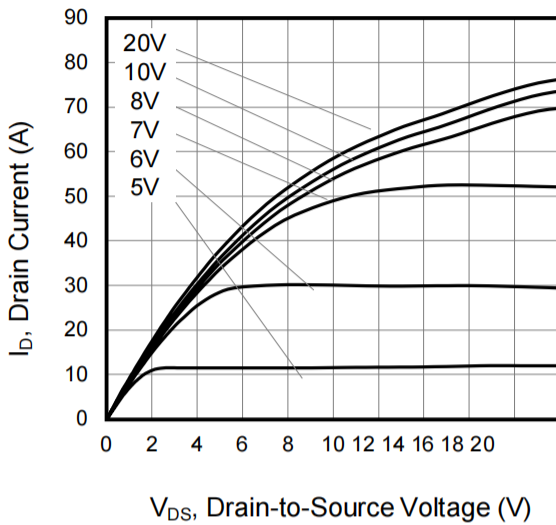
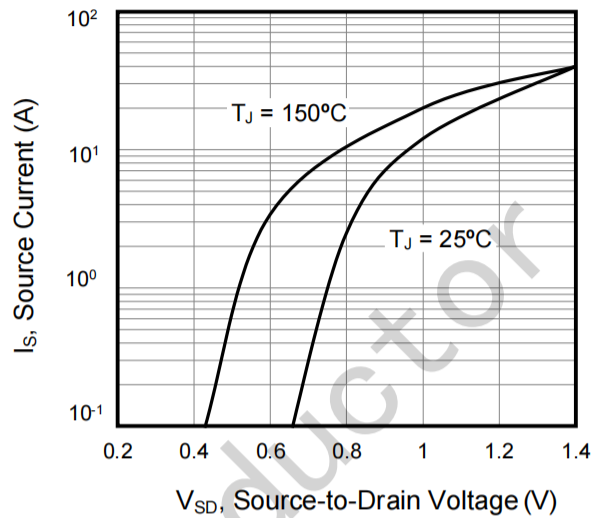
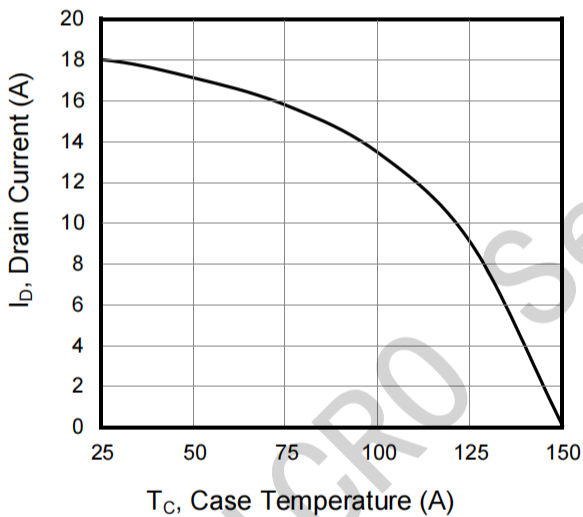
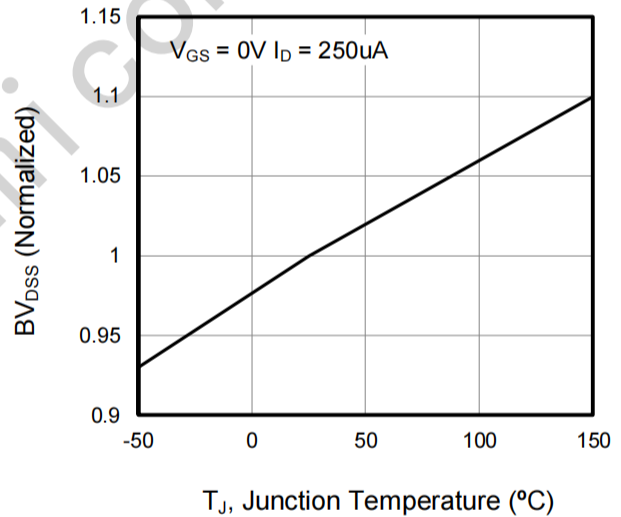
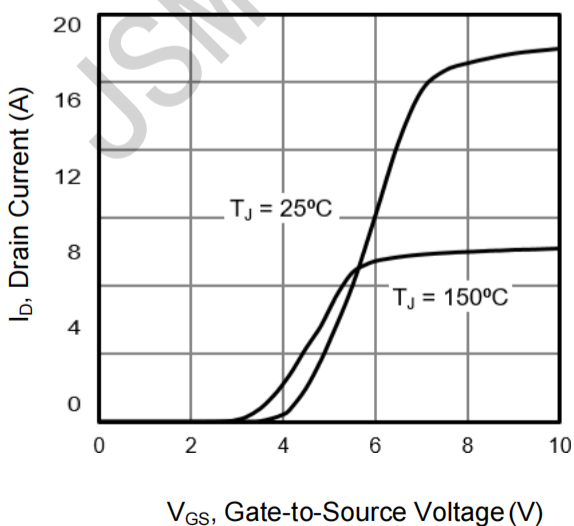
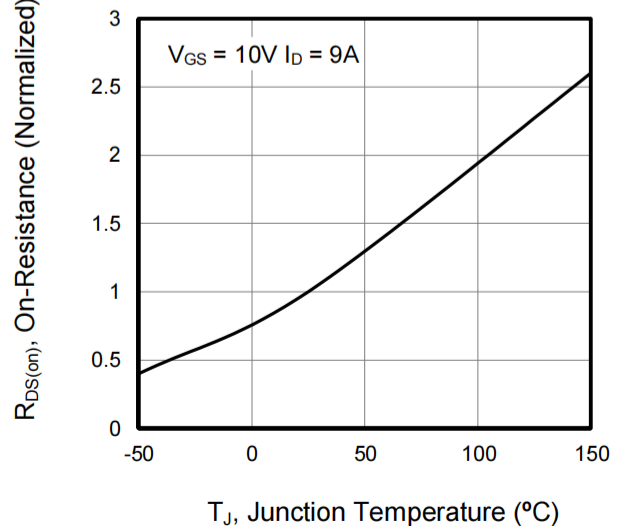
Figure 1. Output Characteristics ($T_J = 25^\circ\text{C}$)

Figure 2. Body Diode Forward Voltage

Figure 3. Drain Current vs. Temperature

Figure 4. BV_{DSS} Variation vs. Temperature

Figure 5. Transfer Characteristics

Figure 6. On-Resistance vs. Temperature

Typical Characteristics $T_J = 25^\circ\text{C}$, unless otherwise noted

Figure 7. Capacitance

Figure 8. Gate Charge

Figure 9. Transient Thermal Impedance TO-220F

Figure 10. Transient Thermal Impedance TO-220

Figure A: Gate Charge Test Circuit and Waveform

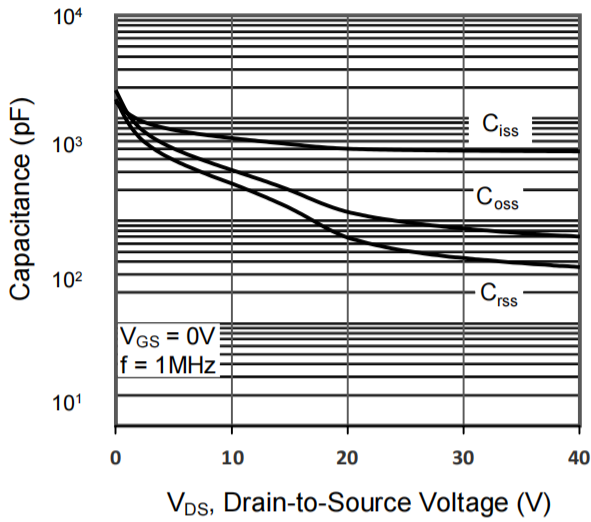
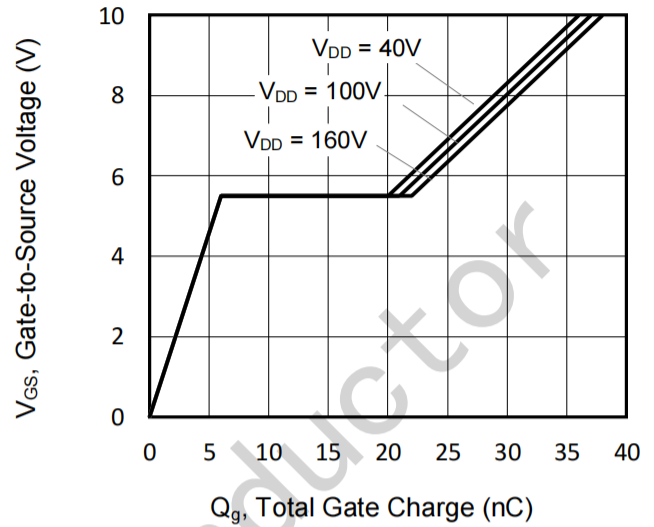
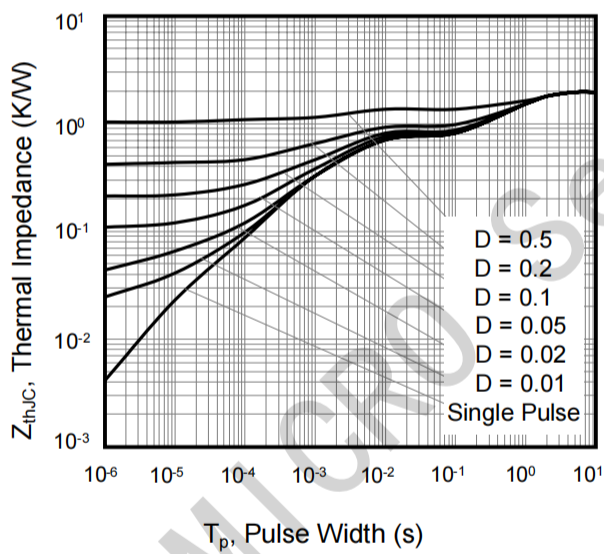
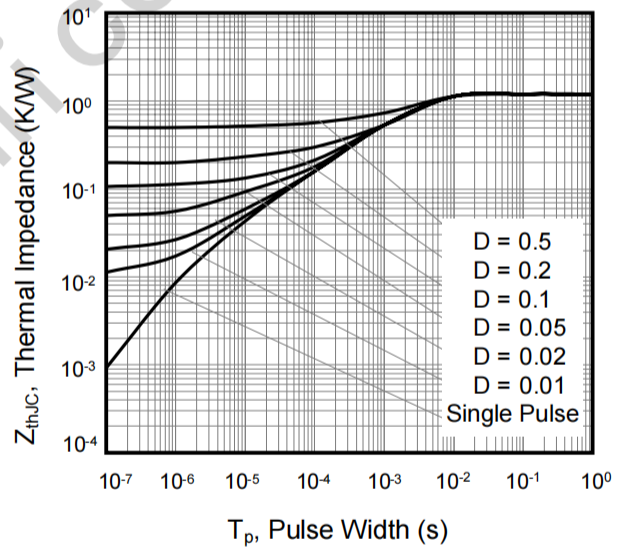
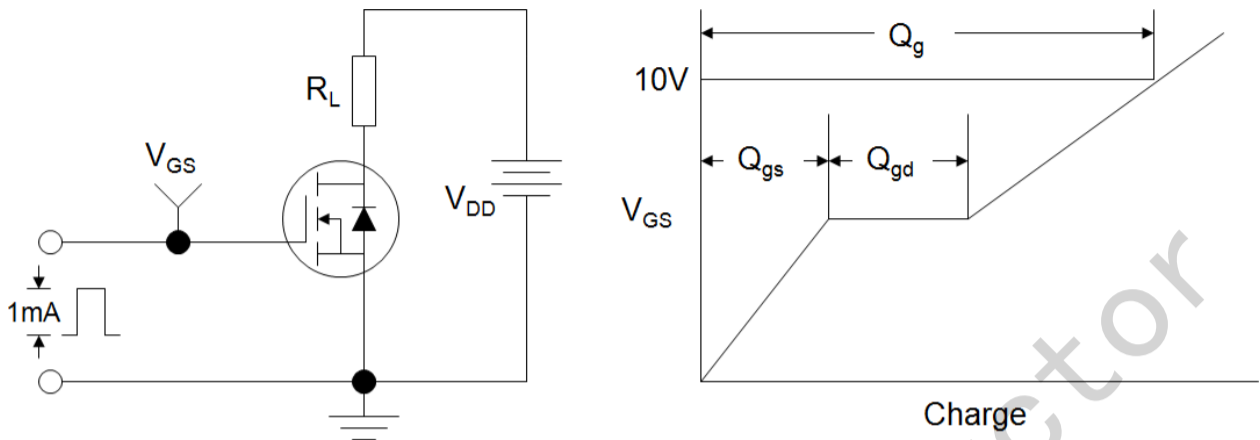
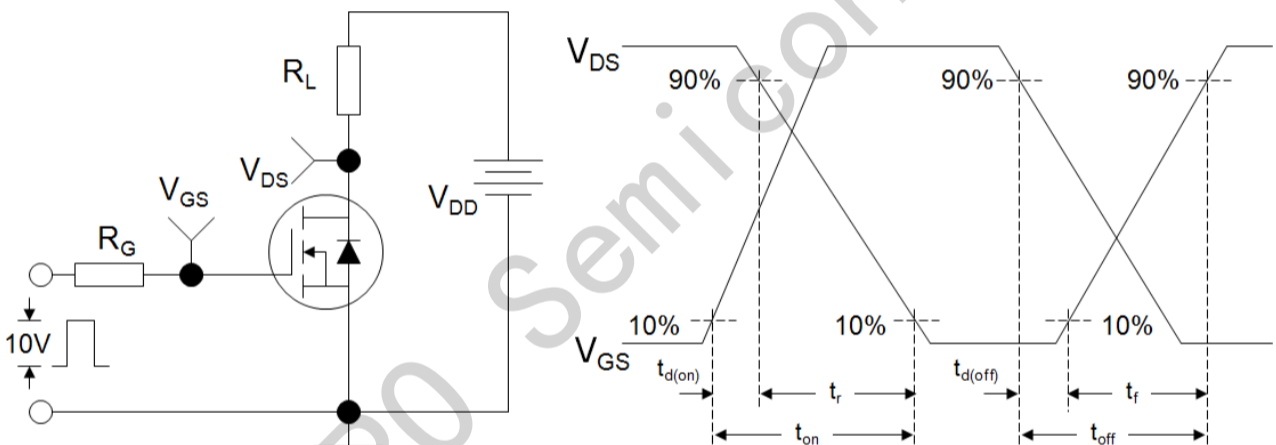
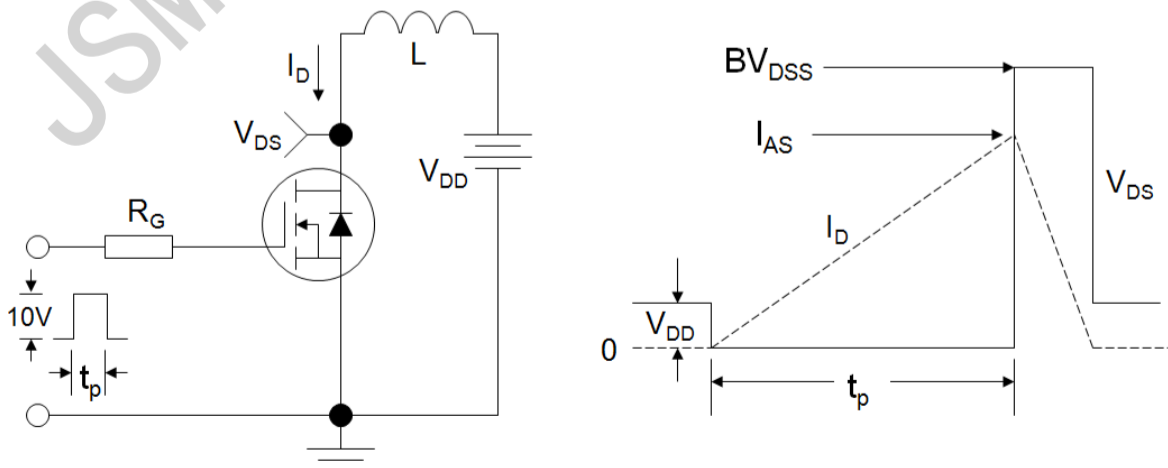
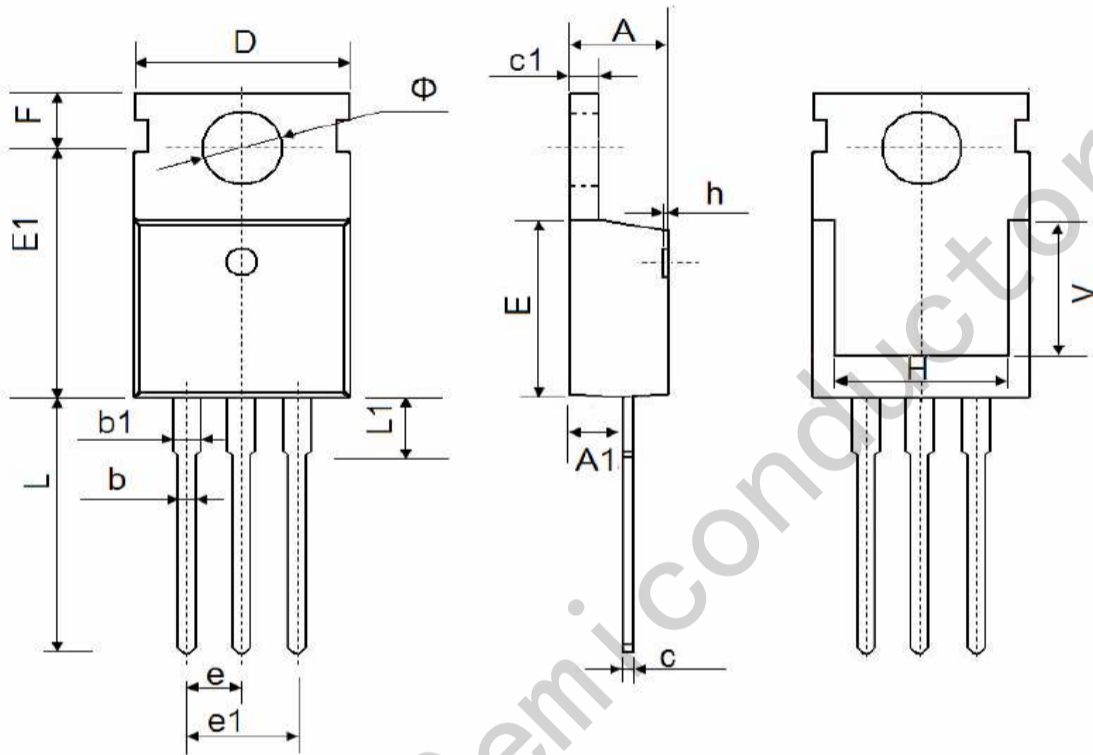
Figure B: Resistive Switching Test Circuit and Waveform

Figure C: Unclamped Inductive Switching Test Circuit and Waveform

外形尺寸图 / Package Dimensions

TO-220-3L

Dimensions in mm



Symbol	Dimensions In Millimeters		Dimensions In Inches	
	Min.	Max.	Min.	Max.
A	4.30	4.70	0.169	0.185
A1	2.25	2.55	0.089	0.100
b	0.71	0.91	0.028	0.036
b1	1.17	1.37	0.046	0.054
c	0.33	0.65	0.013	0.026
c1	1.20	1.40	0.047	0.055
D	9.91	10.25	0.390	0.404
E	8.95	9.75	0.352	0.384
E1	12.65	12.95	0.498	0.510
e	2.54 BSC.		0.100 BSC.	
e1	4.98	5.18	0.196	0.204
F	2.65	2.95	0.104	0.116
H	7.90	8.10	0.311	0.319
h	0.00	0.30	0.000	0.012
L	12.90	13.40	0.508	0.528
L1	2.85	3.25	0.112	0.128
V	7.500 Ref.		0.295 Ref.	
Φ	3.400	3.800	0.134	0.150