

FEATURES

- Fast switching
- 100% avalanche tested
- Improved dv/dt capability

APPLICATIONS

- Switch Mode Power Supply (SMPS)
- Uninterruptible Power Supply (UPS)
- Power Factor Correction (PFC)

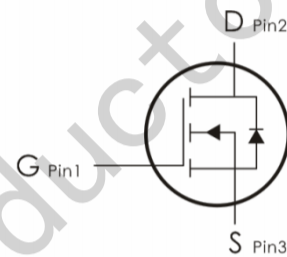
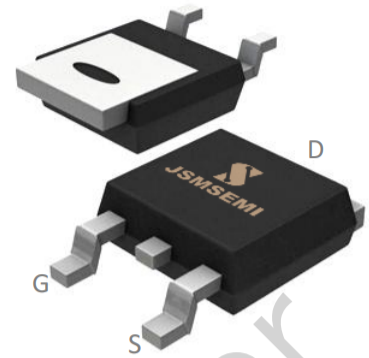

Device Marking and Package Information

Device	Package	Marking
FQD7N20LTM	TO-252	FQD7N20

Absolute Maximum Ratings $T_C = 25^\circ\text{C}$, unless otherwise noted

Parameter	Symbol	Value	Unit
		TO-252	
Drain-Source Voltage ($V_{GS} = 0\text{V}$)	V_{DSS}	200	V
Continuous Drain Current	I_D	9	A
Pulsed Drain Current (note1)	I_{DM}	36	A
Gate-Source Voltage	V_{GSS}	± 20	V
Single Pulse Avalanche Energy (note2)	E_{AS}	115	mJ
Avalanche Current (note1)	I_{AS}	5	A
Repetitive Avalanche Energy (note1)	E_{AR}	69	mJ
Power Dissipation ($T_C = 25^\circ\text{C}$)	P_D	74	W
Operating Junction and Storage Temperature Range	T_J, T_{stg}	-55~+150	$^\circ\text{C}$

Thermal Resistance

Parameter	Symbol	Value	Unit
		TO-252	
Thermal Resistance, Junction-to-Case	R_{thJC}	1.7	K/W
Thermal Resistance, Junction-to-Ambient	R_{thJA}	60	

Specifications $T_J = 25^\circ\text{C}$, unless otherwise noted						
Parameter	Symbol	Test Conditions	Value			Unit
			Min.	Typ.	Max.	
Static						
Drain-Source Breakdown Voltage	$V_{(BR)DSS}$	$V_{GS} = 0V, I_D = 250\mu A$	200	--	--	V
Zero Gate Voltage Drain Current	I_{DSS}	$V_{DS} = 200V, V_{GS} = 0V, T_J = 25^\circ\text{C}$	--	--	1	μA
Gate-Source Leakage	I_{GSS}	$V_{GS} = \pm 20V$	--	--	± 100	nA
Gate-Source Threshold Voltage	$V_{GS(th)}$	$V_{DS} = V_{GS}, I_{DS} = 250\mu A$	2.0	--	4.0	V
Drain-Source On-Resistance (Note3)	$R_{DS(on)}$	$V_{GS} = 10V, I_D = 4.5A$	--	0.25	0.3	Ω
Dynamic						
Input Capacitance	C_{iss}	$V_{GS} = 0V,$ $V_{DS} = 25V,$ $f = 1.0\text{MHz}$	--	605	--	pF
Output Capacitance	C_{oss}		--	87	--	
Reverse Transfer Capacitance	C_{rss}		--	37	--	
Total Gate Charge	Q_g	$V_{DD} = 160V, I_D = 9A,$ $V_{GS} = 10V$	--	19	--	nC
Gate-Source Charge	Q_{gs}		--	3	--	
Gate-Drain Charge	Q_{gd}		--	8	--	
Turn-on Delay Time	$t_{d(on)}$	$V_{DD} = 100V, I_D = 9A,$ $R_G = 25\Omega$	--	35	--	ns
Turn-on Rise Time	t_r		--	7	--	
Turn-off Delay Time	$t_{d(off)}$		--	98	--	
Turn-off Fall Time	t_f		--	32	--	
Drain-Source Body Diode Characteristics						
Continuous Body Diode Current	I_S	$T_C = 25^\circ\text{C}$	--	--	9	A
Pulsed Diode Forward Current	I_{SM}		--	--	36	
Body Diode Voltage	V_{SD}	$T_J = 25^\circ\text{C}, I_{SD} = 4.5A, V_{GS} = 0V$	--	--	1.4	V
Reverse Recovery Time	t_{rr}	$V_{GS} = 0V, I_S = 9A,$ $di_F/dt = 100A/\mu s$	--	145	--	ns
Reverse Recovery Charge	Q_{rr}		--	0.82	--	μC

Notes

1. Repetitive Rating: Pulse width limited by maximum junction temperature
2. $L=10\text{mH}, V_{DD} = 50V, R_G = 25\Omega$, Starting $T_J = 25^\circ\text{C}$
3. Pulse Test: Pulse width $\leq 300\mu s$, Duty Cycle $\leq 1\%$

Typical Characteristics $T_J = 25^\circ\text{C}$, unless otherwise noted

Figure 1. Output Characteristics ($T_J = 25^\circ\text{C}$)

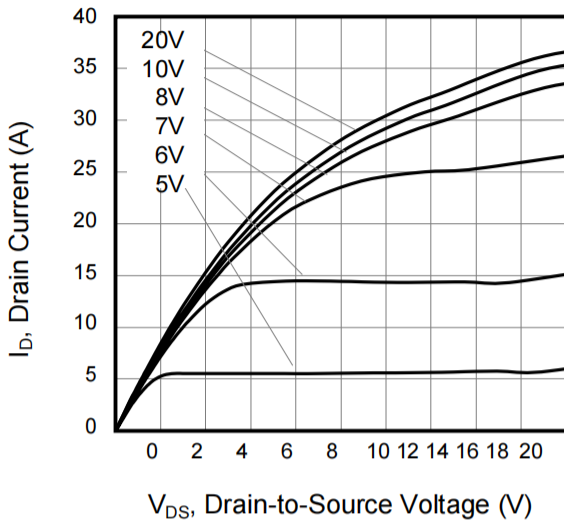

Figure 2. Body Diode Forward Voltage

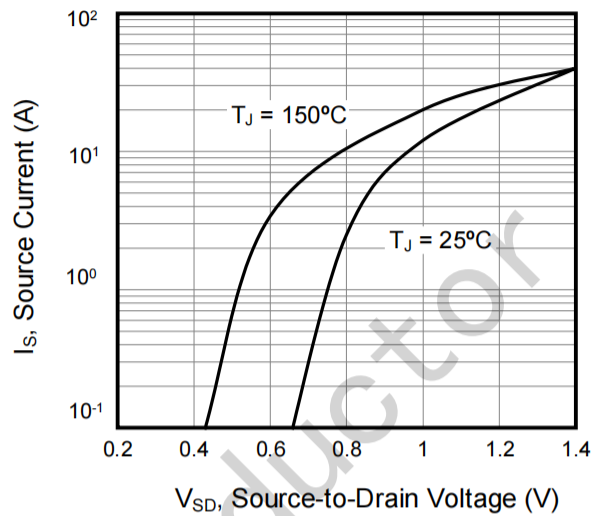

Figure 3. Drain Current vs. Temperature

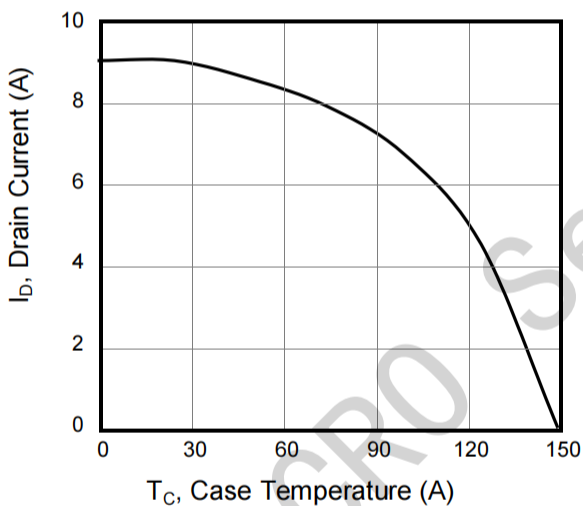

Figure 4. BV_{DSS} Variation vs. Temperature

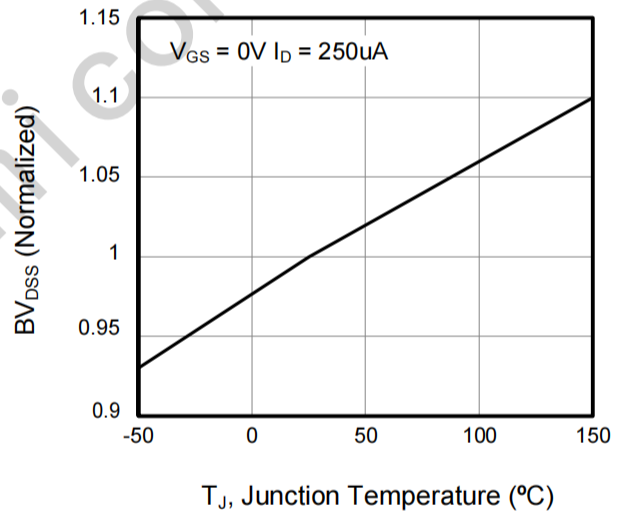

Figure 5. Transfer Characteristics

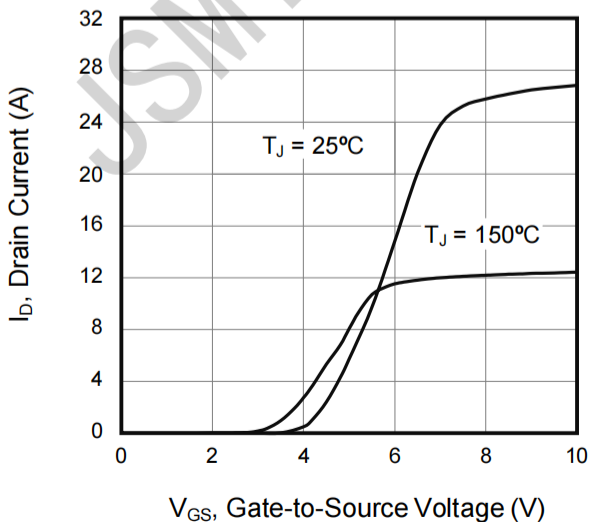

Figure 6. On-Resistance vs. Temperature

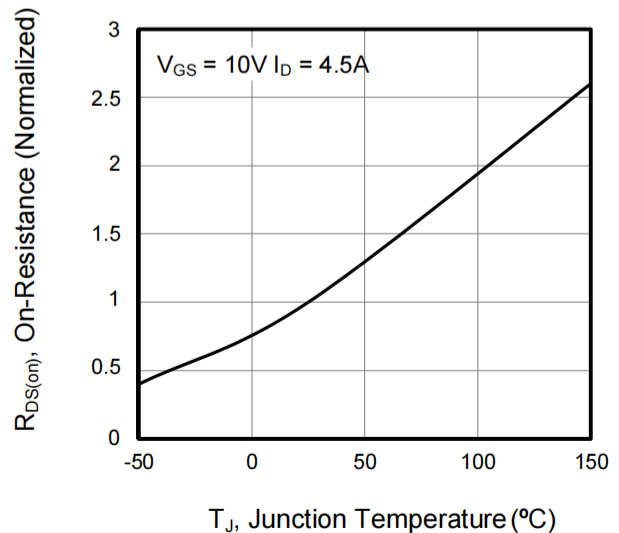

Figure 7. Capacitance

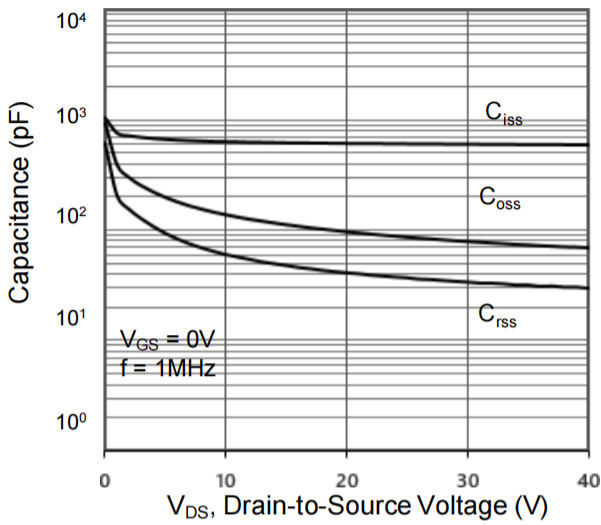

Figure 8. Gate Charge

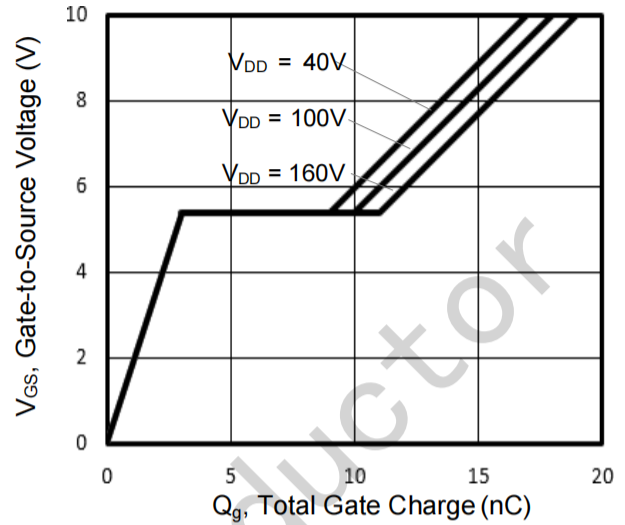

Figure 9. Transient Thermal Impedance

TO-252

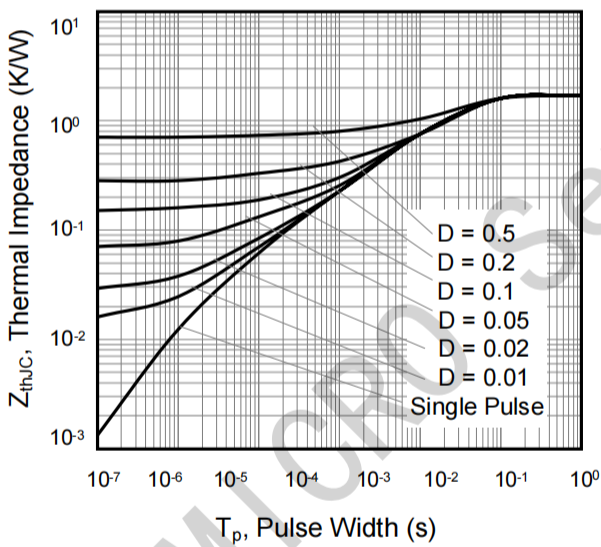

Figure A: Gate Charge Test Circuit and Waveform

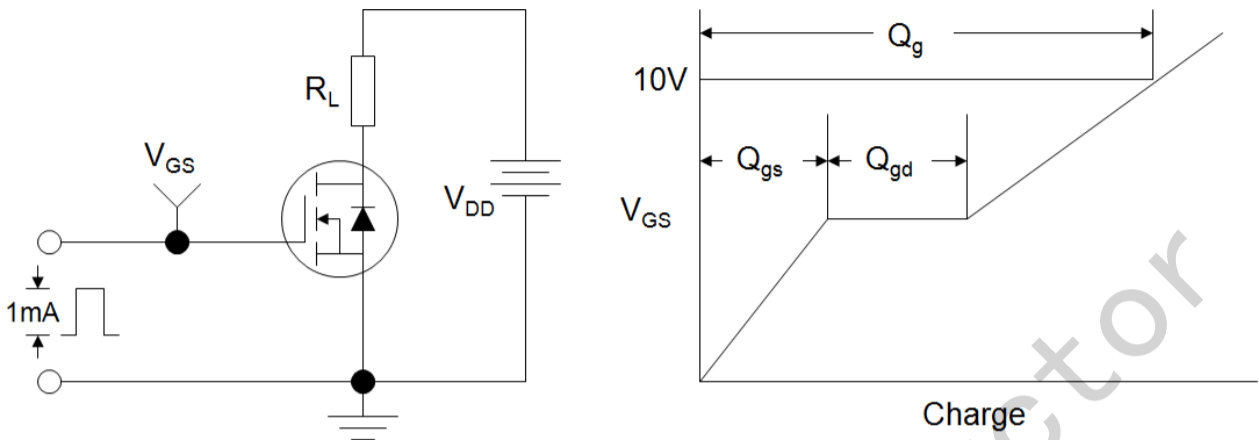

Figure B: Resistive Switching Test Circuit and Waveform

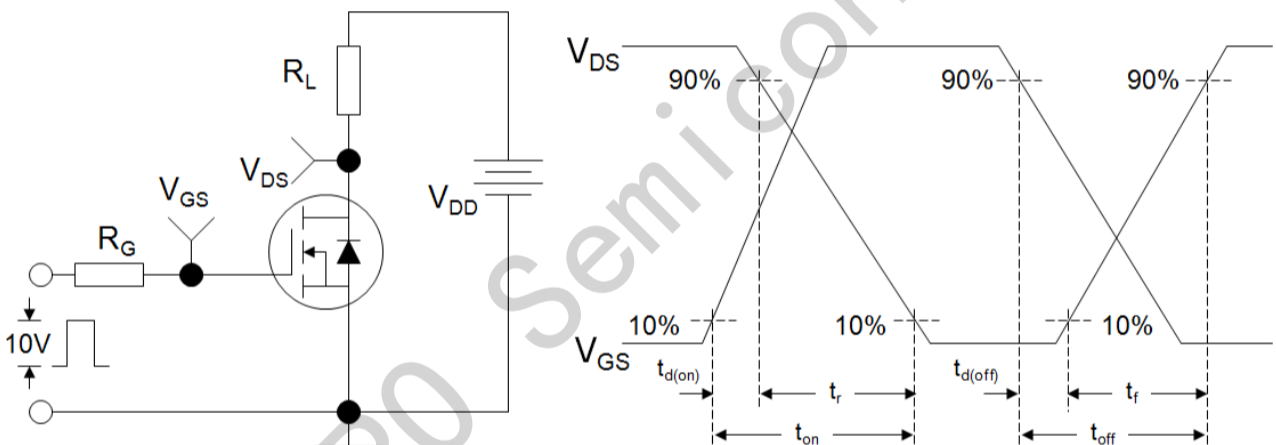
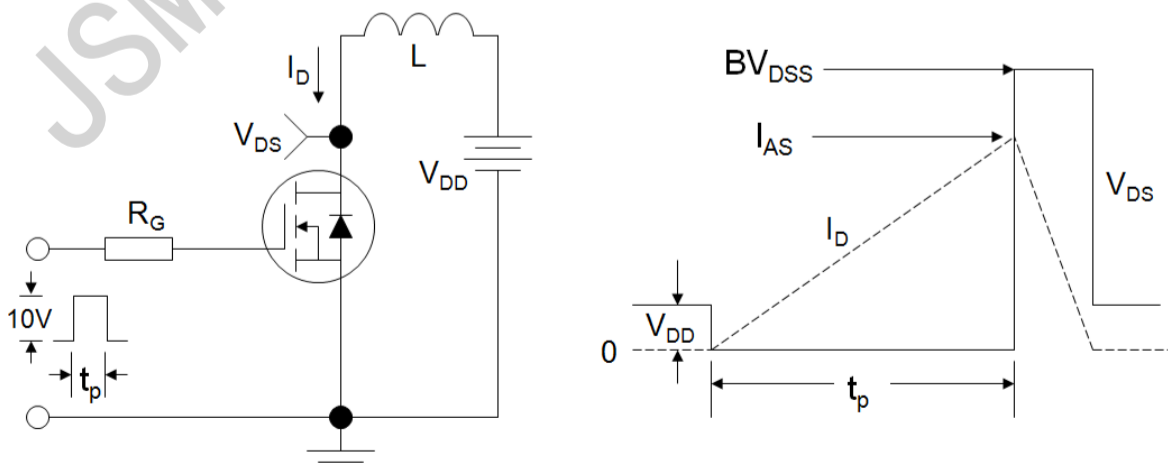
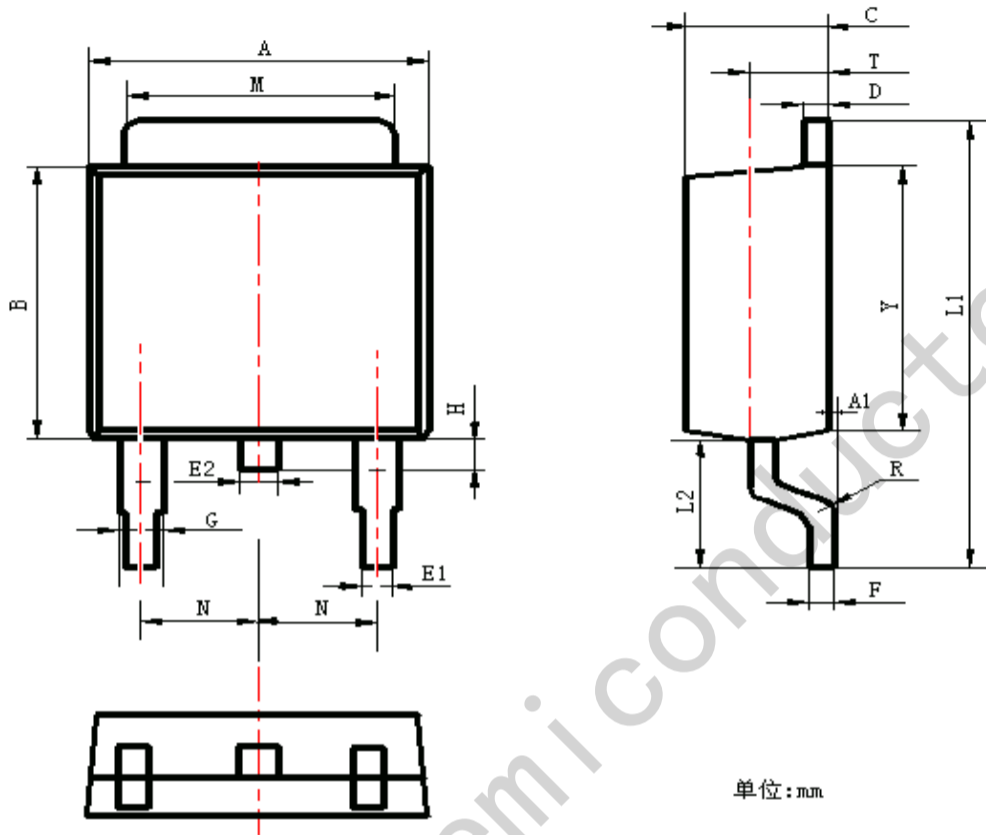

Figure C: Unclamped Inductive Switching Test Circuit and Waveform



TO-252 Package Information



单位: mm

Symbol	Dimensions In Millimeters		Dimensions In Inches	
	Min.	Max.	Min.	Max.
A	6.30	6.90	0.248	0.272
A1	0.00	0.16	0.000	0.006
B	5.70	6.30	0.224	0.248
C	2.10	2.50	0.083	0.098
D	0.30	0.70	0.012	0.028
E1	0.60	0.90	0.024	0.035
E2	0.70	1.00	0.028	0.039
F	0.30	0.60	0.012	0.024
G	0.70	1.20	0.028	0.047
L1	9.60	10.50	0.378	0.413
L2	2.70	3.10	0.106	0.122
H	0.40	1.00	0.016	0.039
M	5.10	5.50	0.201	0.217
N	2.09	2.49	0.082	0.098
R	0.30		0.012	
T	1.40	1.60	0.055	0.063
Y	5.10	6.30	0.201	0.248