

TO-126 Plastic-Encapsulate Transistors

BD136 / BD138 / BD140 TRANSISTOR (PNP)

FEATURES

- High Current
- Complement To BD135, BD137 And BD139

MARKING

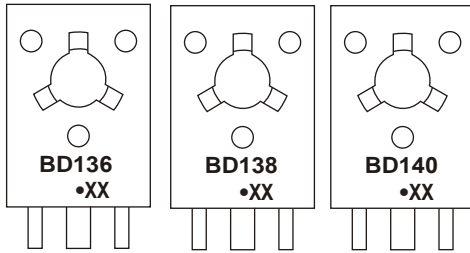

BD136, BD138, BD140 = Device code
 Solid dot = Green molding compound device,
 if none, the normal device
 XX = Code

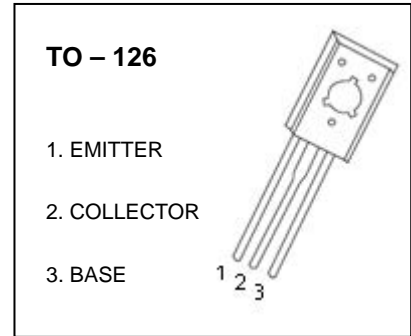

Equivalent Circuit

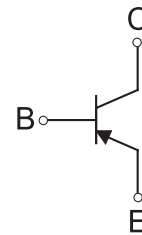

ORDERING INFORMATION

Part Number	Package	Packing Method	Pack Quantity
BD136	TO-126	Bulk	200pcs/Bag
BD138	TO-126	Bulk	200pcs/Bag
BD140	TO-126	Bulk	200pcs/Bag
BD136-TU	TO-126	Tube	60pcs/Tube
BD138-TU	TO-126	Tube	60pcs/Tube
BD140-TU	TO-126	Tube	60pcs/Tube

MAXIMUM RATINGS (T_a=25°C unless otherwise noted)

Symbol	Parameter	Value	Unit
V _{CBO}	Collector-Base Voltage	BD136	-45
		BD138	-60
		BD140	-80
V _{CEO}	Collector-Emitter Voltage	BD136	-45
		BD138	-60
		BD140	-80
V _{EBO}	Emitter-Base Voltage	-5	V
I _C	Collector Current	-1.5	A
P _C	Collector Power Dissipation	1.25	W
R _{θJA}	Thermal Resistance From Junction To Ambient	100	°C/W
T _J , T _{stg}	Junction Temperature	-55~+150	°C

ELECTRICAL CHARACTERISTICS

$T_a=25\text{ }^\circ\text{C}$ unless otherwise specified

Parameter	Symbol	Test conditions	Min	Typ	Max	Unit
Collector-base breakdown voltage BD136 BD138 BD140	$V_{(BR)CBO}$	$I_C=-0.1\text{mA}, I_E=0$	-45 -60 -80			V
Collector-emitter sustaining voltage BD136 BD138 BD140	$V_{CEO(SUS)}^*$	$I_C=-0.03\text{A}, I_B=0$	-45 -60 -80			V
Emitter-base breakdown voltage	$V_{(BR)EBO}$	$I_E=-0.1\text{mA}, I_C=0$	-5			V
Collector cut-off current	I_{CBO}	$V_{CB}=-30\text{V}, I_E=0$			-0.1	μA
Emitter cut-off current	I_{EBO}	$V_{EB}=-5\text{V}, I_C=0$			-10	μA
DC current gain	$h_{FE(1)}^*$	$V_{CE}=-2\text{V}, I_C=-150\text{mA}$	40		250	
	$h_{FE(2)}^*$	$V_{CE}=-2\text{V}, I_C=-5\text{mA}$	25			
	$h_{FE(3)}^*$	$V_{CE}=-2\text{V}, I_C=-500\text{mA}$	25			
Collector-emitter saturation voltage	$V_{CE(sat)}^*$	$I_C=-500\text{mA}, I_B=-50\text{mA}$			-0.5	V
Base-emitter voltage	V_{BE}^*	$V_{CE}=-2\text{V}, I_C=-500\text{mA}$			-1	V

*Pulse test: pulse width $\leq 350\mu\text{s}$, duty cycle $\leq 2.0\%$.

CLASSIFICATION OF $h_{FE(1)}$

RANK	6	10	16
RANGE	40-100	63-160	100-250

Typical Characteristics

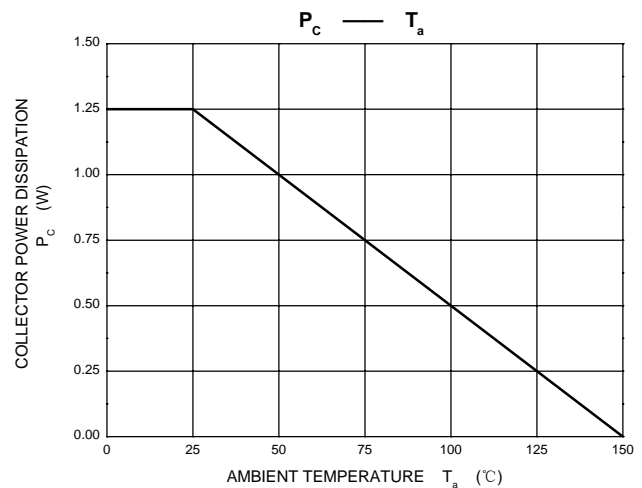
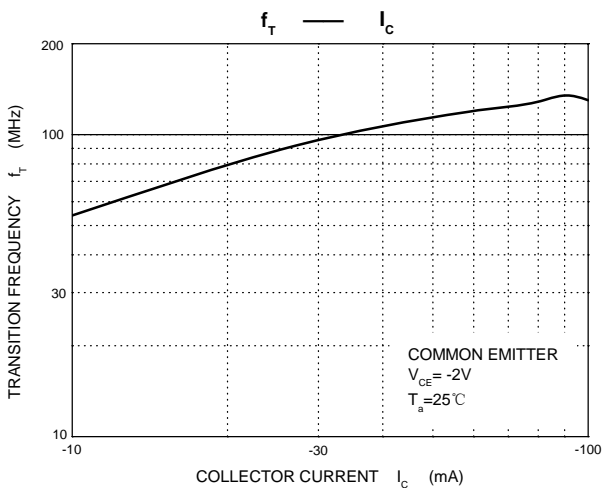
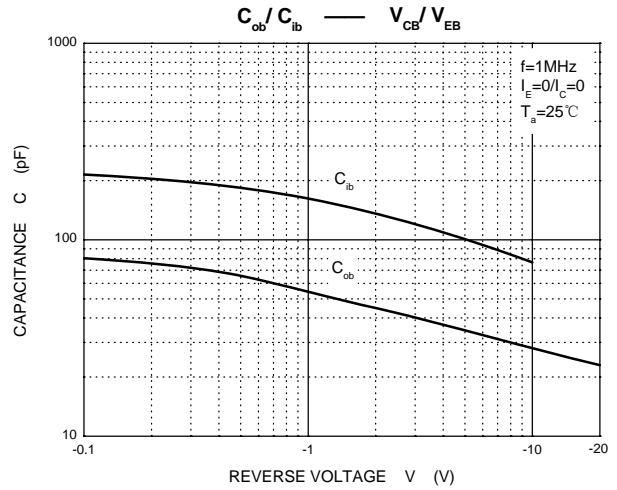
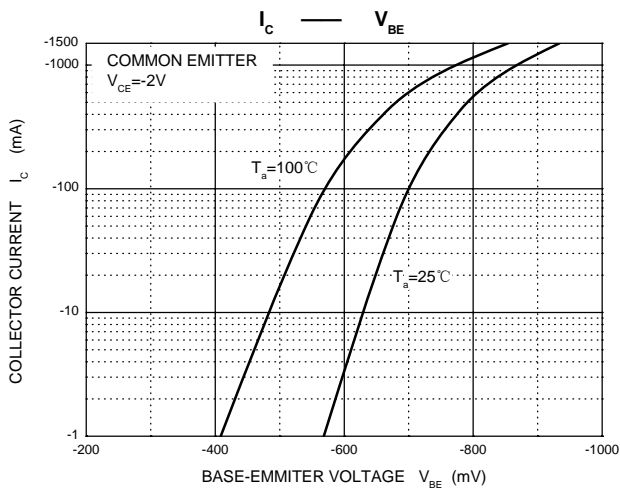
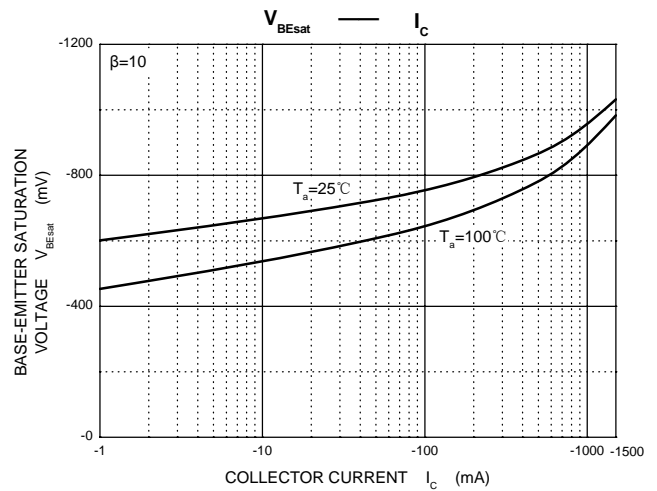
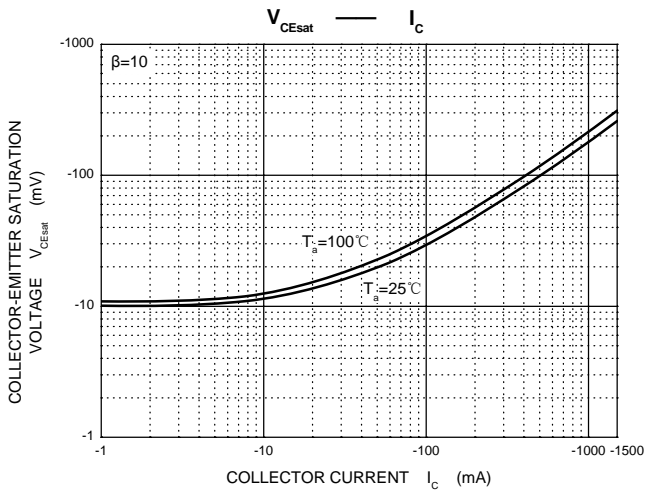
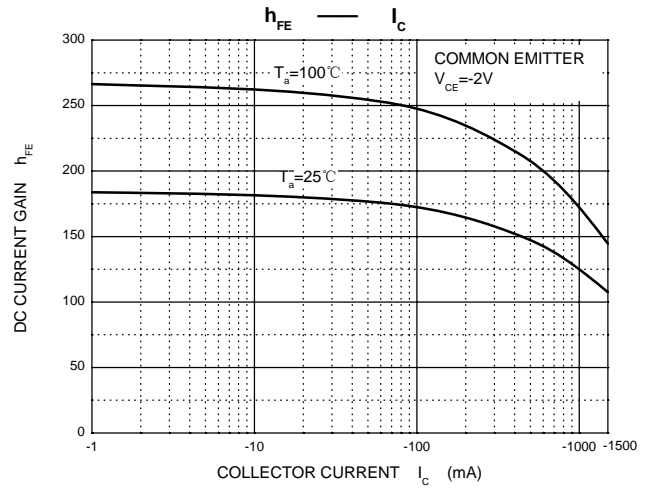
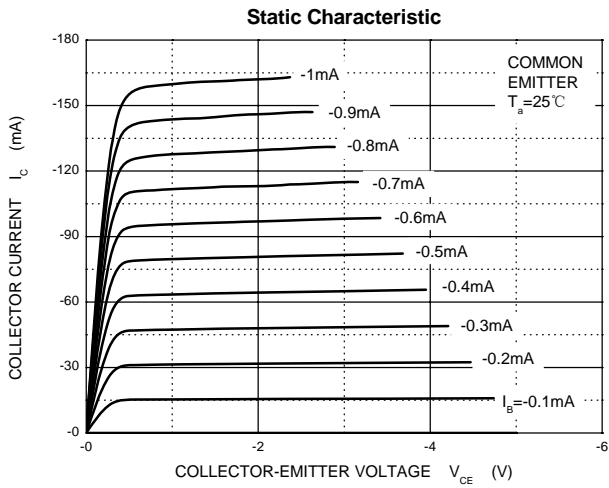

TO-126 Package Outline Dimensions



Symbol	Dimensions In Millimeters		Dimensions In Inches	
	Min	Max	Min	Max
A	2.500	2.900	0.098	0.114
A1	1.100	1.500	0.043	0.059
b	0.660	0.860	0.026	0.034
b1	1.170	1.370	0.046	0.054
c	0.450	0.600	0.018	0.024
D	7.400	7.800	0.291	0.307
E	10.600	11.000	0.417	0.433
e	2.290 TYP		0.090 TYP	
e1	4.480	4.680	0.176	0.184
h	0.000	0.300	0.000	0.012
L	15.300	15.700	0.602	0.618
L1	2.100	2.300	0.083	0.091
P	3.900	4.100	0.154	0.161
ϕ	3.000	3.200	0.118	0.126