

■ DESCRIPTION

The 4468 is the N-Channel logic enhancement mode power field effect transistor is produced using high cell density advanced trench technology..

This high density process is especially tailored to minimize on-state resistance. These devices are particularly suited for low voltage application, notebook computer power management and other battery powered circuits where high-side switching

■ FEATURE

- ◆ 30V/10 A, $R_{DS(ON)}=16m\Omega$ (typ.)@VGS= 10V
- ◆ 30V/10A, $R_{DS(ON)}=20m\Omega$ (typ.)@VGS= 4.5V
- ◆ Super high design for extremely low $R_{DS(ON)}$
- ◆ Exceptional on-resistance and Maximum DC current capability
- ◆ Full RoHS compliance
- ◆ SOP8 package design
- ◆ 100% UIS Tested
- ◆ 100% Rg tested

■ APPLICATIONS

- ◆ Power Management
- ◆ Portable Equipment
- ◆ DC/DC Converter
- ◆ Load Switch
- ◆ DSC
- ◆ LCD Display inverter

■ PIN CONFIGURATION

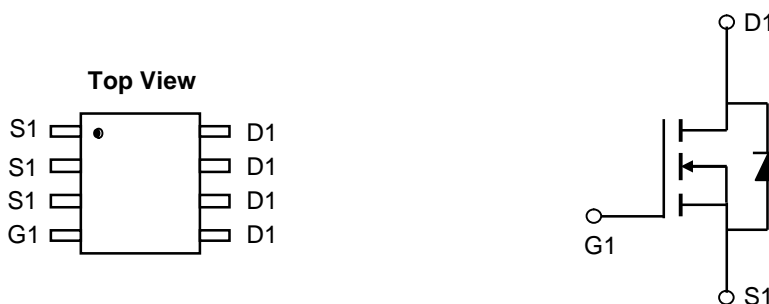

■ **ABSOLUTE MAXIMUM RATINGS** ($T_A = 25^\circ\text{C}$ Unless otherwise noted)

Symbol	Parameter	Typical	Unit
V_{DSS}	Drain-Source Voltage	30	V
V_{GSS}	Gate-Source Voltage	± 20	V
I_D	Continuous Drain Current ($T_J=150^\circ\text{C}$)	$V_{GS}=10\text{V}$ 10	A
I_{DM}	Pulsed Drain Current	40	A
I_S	Continuous Source Current (Diode Conduction)	4.0	A
P_D	Power Dissipation	$T_A=25^\circ\text{C}$	W
		$T_A=70^\circ\text{C}$	
T_J	Operation Junction Temperature	150	$^\circ\text{C}$
T_{STG}	Storage Temperature Range	-55~+150	$^\circ\text{C}$
$R_{\theta JA}$	Thermal Resistance Junction to Ambient	62.5	$^\circ\text{C/W}$

Note: Absolute maximum ratings are those values beyond which the device could be permanently damaged. Absolute maximum ratings are stress rating only and functional device operation is not implied

ELECTRICAL CHARACTERISTICS ($T_A=25^\circ\text{C}$ Unless otherwise noted)

Symbol	Parameter	Condition	Min	Typ	Max	Unit
Static Parameters						
$V_{(BR)DSS}$	Drain-Source Breakdown Voltage	$V_{GS}=0V, I_D=250\mu A$	30			V
$V_{GS(th)}$	Gate Threshold Voltage	$V_{DS}=V_{GS}, I_D=250\mu A$	1.0		2.0	V
I_{GSS}	Gate Leakage Current	$V_{DS}=0V, V_{GS}=\pm 20V$			± 100	nA
I_{DSS}	Zero Gate Voltage Drain Current	$V_{DS}=24V, V_{GS}=0$			1	uA
		$V_{DS}=24V, V_{GS}=0$ $T_J=85^\circ\text{C}$			30	
$R_{DS(ON)}$	Drain-Source On-Resistance	$V_{GS}=10V, I_D=10A$		16	25	m Ω
		$V_{GS}=4.5V, I_D=8A$		20	30	
Source-Drain Diode						
V_{SD}	Diode Forward Voltage	$I_S=2.0A, V_{GS}=0V$		0.7	1.3	V
Dynamic Parameters						
Q_g	Total Gate Charge	$V_{DS}=15V$ $V_{GS}=10V$ $I_D=9.0A$		11.6		nC
Q_{gs}	Gate-Source Charge			2.5		
Q_{gd}	Gate-Drain Charge			3.9		
C_{iss}	Input Capacitance	$V_{DS}=25V$ $V_{GS}=0V$ $f=1\text{MHz}$		770		pF
C_{oss}	Output Capacitance			110		
C_{riss}	Reverse Transfer Capacitance			90		
$T_{d(on)}$	Turn-On Time	$V_{DS}=15V$ $R_L=15\Omega$ $I_D=1A$ $V_{GEN}=10V$ $R_G=6\Omega$		5		nS
T_r				3.5		
$T_{d(off)}$	Turn-Off Time			19		
T_f			3.5			

Note: 1. Pulse test: pulse width \leq 300uS, duty cycle \leq 2%

2.Static parameters are based on package level with recommended wire bonding

■ **TYPICAL CHARACTERISTICS (25°C Unless Note)**

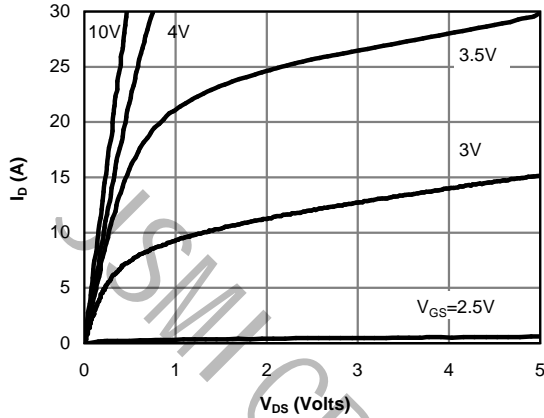

Figure 1: On-Region Characteristics (Note E)

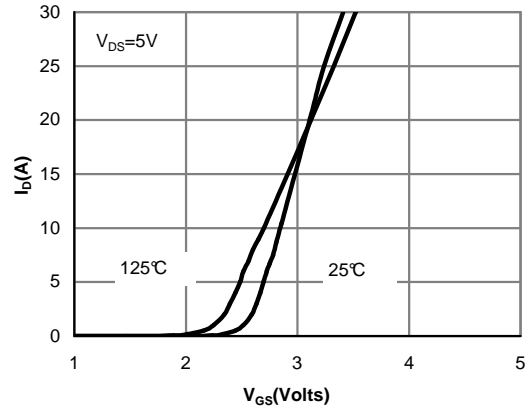

Figure 2: Transfer Characteristics (Note E)

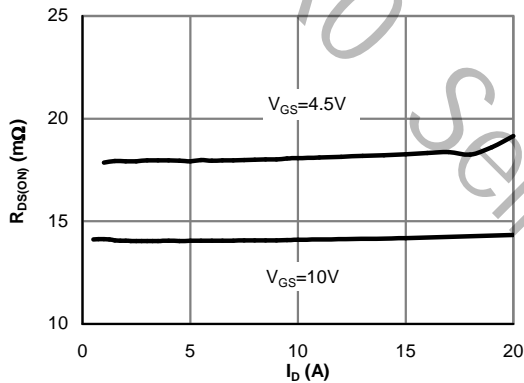

Figure 3: On-Resistance vs. Drain Current and Gate Voltage (Note E)

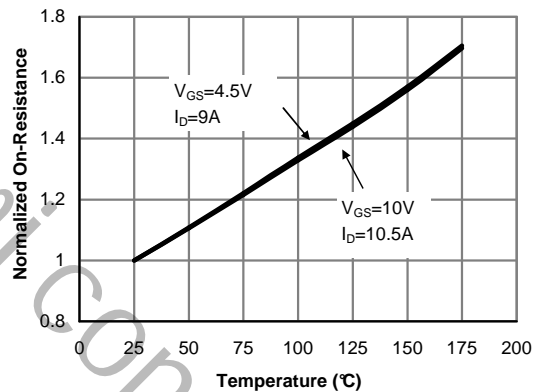

Figure 4: On-Resistance vs. Junction Temperature (Note E)

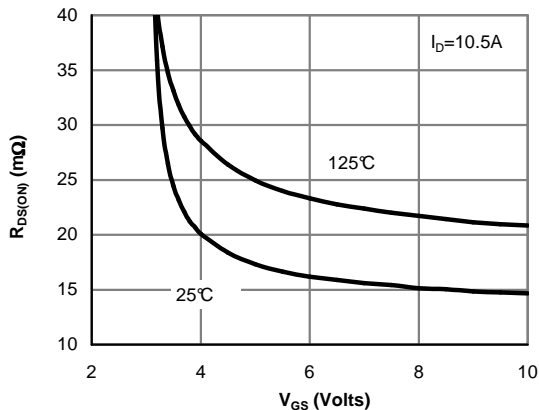

Figure 5: On-Resistance vs. Gate-Source Voltage (Note E)

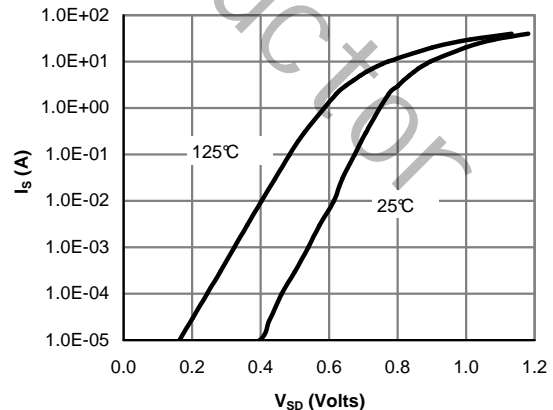

Figure 6: Body-Diode Characteristics (Note E)

■ **TYPICAL CHARACTERISTICS** (continuous)

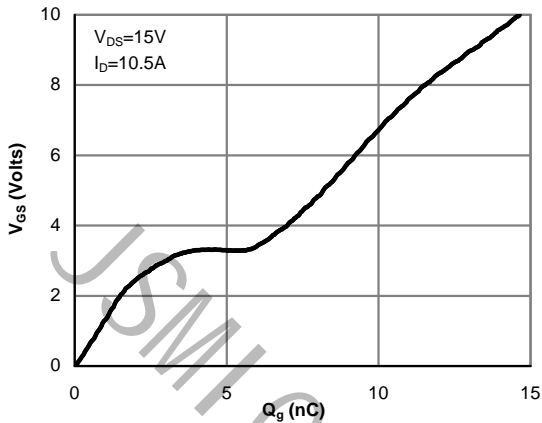

Figure 7: Gate-Charge Characteristics

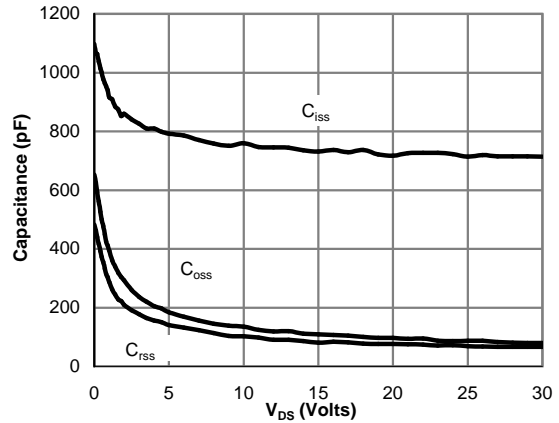

Figure 8: Capacitance Characteristics

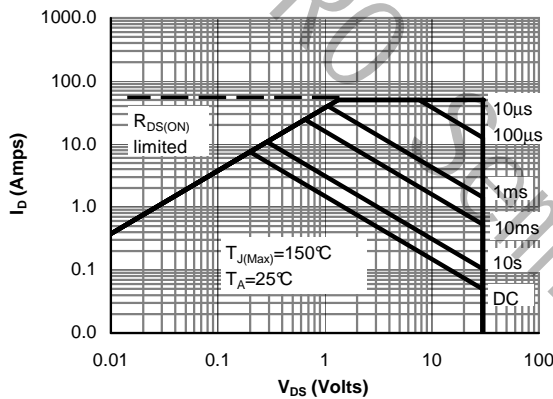

Figure 10: Maximum Forward Biased Safe Operating Area (Note F)

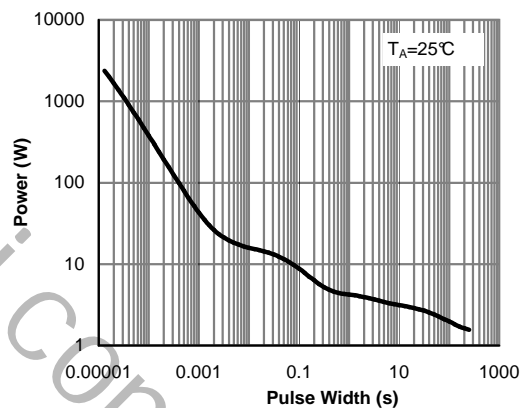

Figure 11: Single Pulse Power Rating Junction-to-Ambient (Note F)

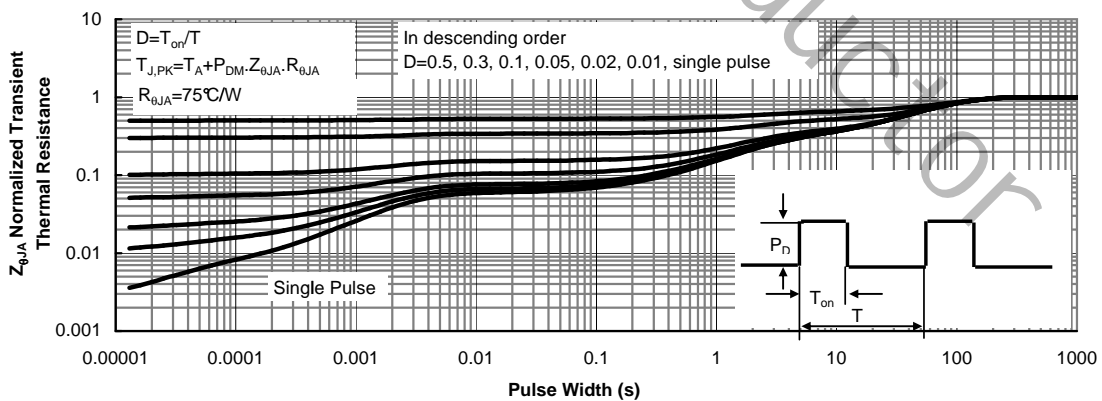
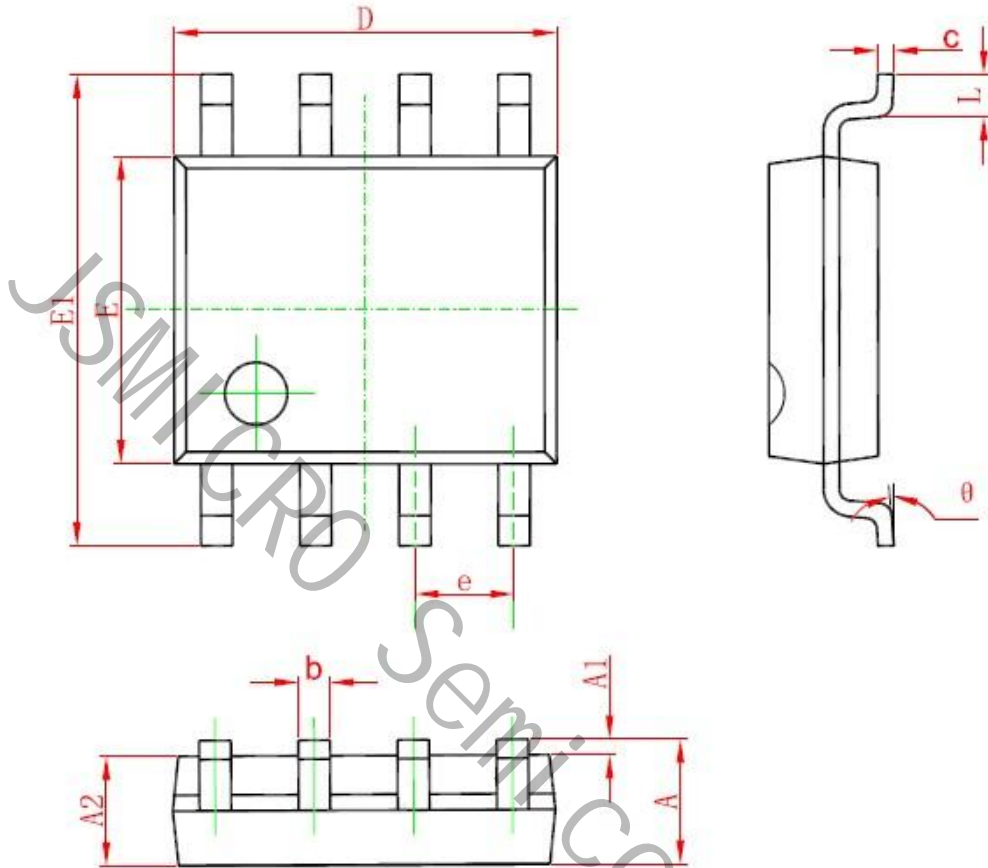

Figure 12: Normalized Maximum Transient Thermal Impedance (Note F)

■ SOP8 PACKAGE OUTLINE DIMENSIONS

Symbol	Dimensions In Millimeters		Dimensions In Inches	
	Min	Max	Min	Max
A	1.350	1.750	0.053	0.069
A1	0.100	0.250	0.004	0.010
A2	1.350	1.550	0.053	0.061
b	0.330	0.510	0.013	0.020
c	0.170	0.250	0.006	0.010
D	4.700	5.100	0.185	0.200
E	3.800	4.000	0.150	0.157
E1	5.800	6.200	0.228	0.244
e	1.270 (BSC)		0.050 (BSC)	
L	0.400	1.270	0.016	0.050
theta	0°	8°	0°	8°

■ SOLDERING METHODS FOR UNIVERCHIP

Storage environment Temperature=10°C~35°C Humidity=65%±15%

Reflow soldering of surface mount device

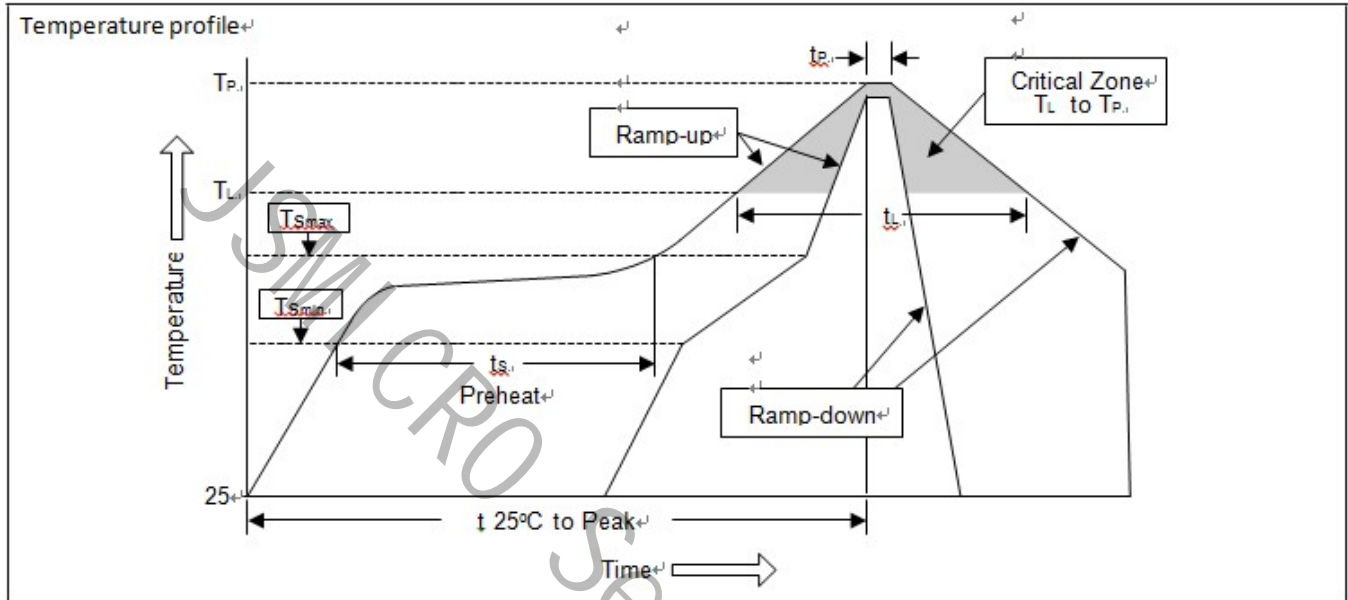

Profile Feature	Sn-Pb Eutectic Assembly	Pb free Assembly
Average ramp-up rate (T _L to T _P)	<3°C/sec	<3°C/sec
Preheat		
-Temperature Min (T _{Smin})	100°C	150°C
-Temperature Max (T _{Smax})	150°C	200°C
-Time (min to max) (t _s)	60~120 sec	60~180 sec
T _{Smax} to T _L		
-Ramp-up Rate	<3°C/sec	<3°C/sec
Time maintained above		
-Temperature (T _L)	183°C	217°C
-Time (t _L)	60~150 sec	60~150 sec
Peak Temperature (T _P)	240°C+0/-5°C	260°C+0/-5°C
Time within 5°C of actual Peak Temperature (t _p)	10~30 sec	20~40 sec
Ramp-down Rate	<6°C/sec	<6°C/sec
Time 25°C to Peak Temperature	<6 minutes	<6 minutes

Flow (wave) soldering (solder dipping)

Product	Peak Temperature	Dipping Time
Pb device	245°C±5°C	5sec±1sec
Pb-Free device	260°C+0/-5°C	5sec±1sec

JSMICRO Semi conductor