

| REVISION RECORD | | | | |
|-----------------|-----|------------------|-------|----------|
| REV | ECO | DESCRIPTION | DRFT | DATE |
| △ | | Drawing Revise | Haoyh | 03/18/06 |
| △ | | 品名、料号增加环保标示“(H)” | CSX | 12/10/07 |
| △ | | 修改参数 | LJH | 09/19/08 |
| △ | | 修改线径参数 | Zengy | 07/27/09 |

Notes:

1. Pitch: 3.81mm, Poles: 2-XXP
2. Rated voltage/current: UL 300V/7A
VDE 130V/10A
3. Operation temperatures: -40°C ~ +105°C
4. Withstanding Voltage: AC2000V/1Min
5. Insulation Resistance: 5000MΩ / DC1000V
6. Wire Range: 24~18AWG, 1.0mm² △
7. Max. Torque Value: M2, 2.04kgf.cm
8. Undimensioned Tolerances:

| Pitch range in mm | | Nominal dimension range in mm | | | | — |
|-------------------|-------|-------------------------------|------|------|------|---------|
| to | over | to | over | over | over | — |
| 6 | 10 | 24 | 30 | 60 | 100 | 150 |
| ±0.10 | ±0.15 | ±0.25 | ±0.2 | ±0.3 | ±0.5 | ±0.7 |
| | | | | | | ±1.0 |
| | | | | | | 0.05/10 |

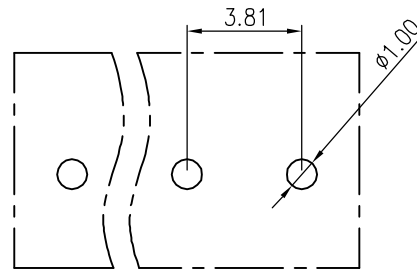
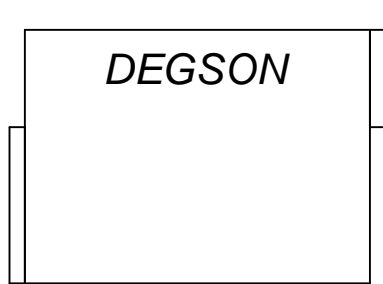
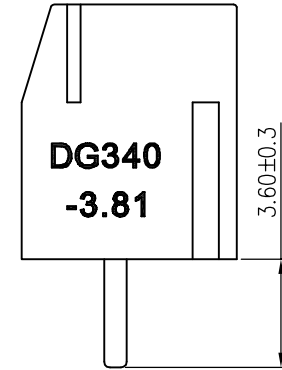
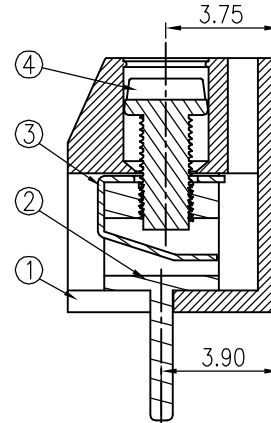
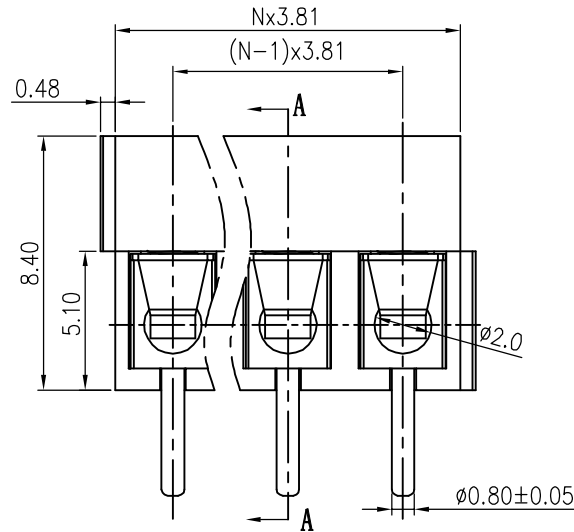
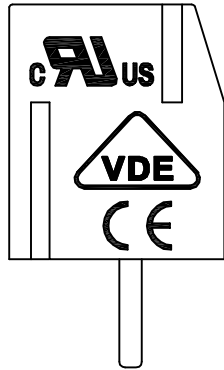
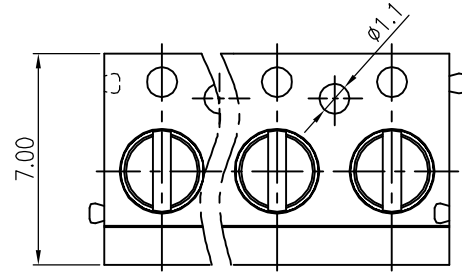

| ITEM | NAME OF PART | NO. OF PART | Q'TY | MATERIAL | NOTES |
|------|----------------------|----------------|------|-----------------|-------------|
| 4 | DG350-Screws | S000001400 (H) | XX | Steel | Cr*Zn |
| 3 | DG350-Spring | X000000290 (H) | XX | Phosphor bronze | Ni plated |
| 2 | DG350 (A) Pin header | 4017B00010 (H) | XX | Brass | SnCe plated |
| 1 | DG340-3.81-Housing | 4015A0YXXA (H) | 1 | PA66 | UL94V-0 |

| | | | |
|--|--|---|--|
| DFTO TONGXC DATE 11/13/04 CHKD DATE TOLERANCES EXCEPT AS NOTED MFO DATE APPVL DATE | | 宁波高正电子有限公司 DEGSON ELECTRONICS CO., LTD | |
| DETACHED LISTS MM .0 ± ± .00 ± ± .000 ± ± | | NAME DG340-3.81-XXP-1Y-00A(H) | |
| ANGLES ± 1° G.E : FINISH : THIRD ANGLE PROJECTION | | DRAWING NO. DG340-3.81-E01 /PART NO. DO NOT SCALE DRAWING | |
| SCALE : 1:1 | | SIZE A3 REV T4 07/27/09 | |
| SHEET 1 OF 1 | | | |